

# OPERATOR'S MANUAL

**0843K**

**For Models  
M843JK, M843NK, NL843NK**

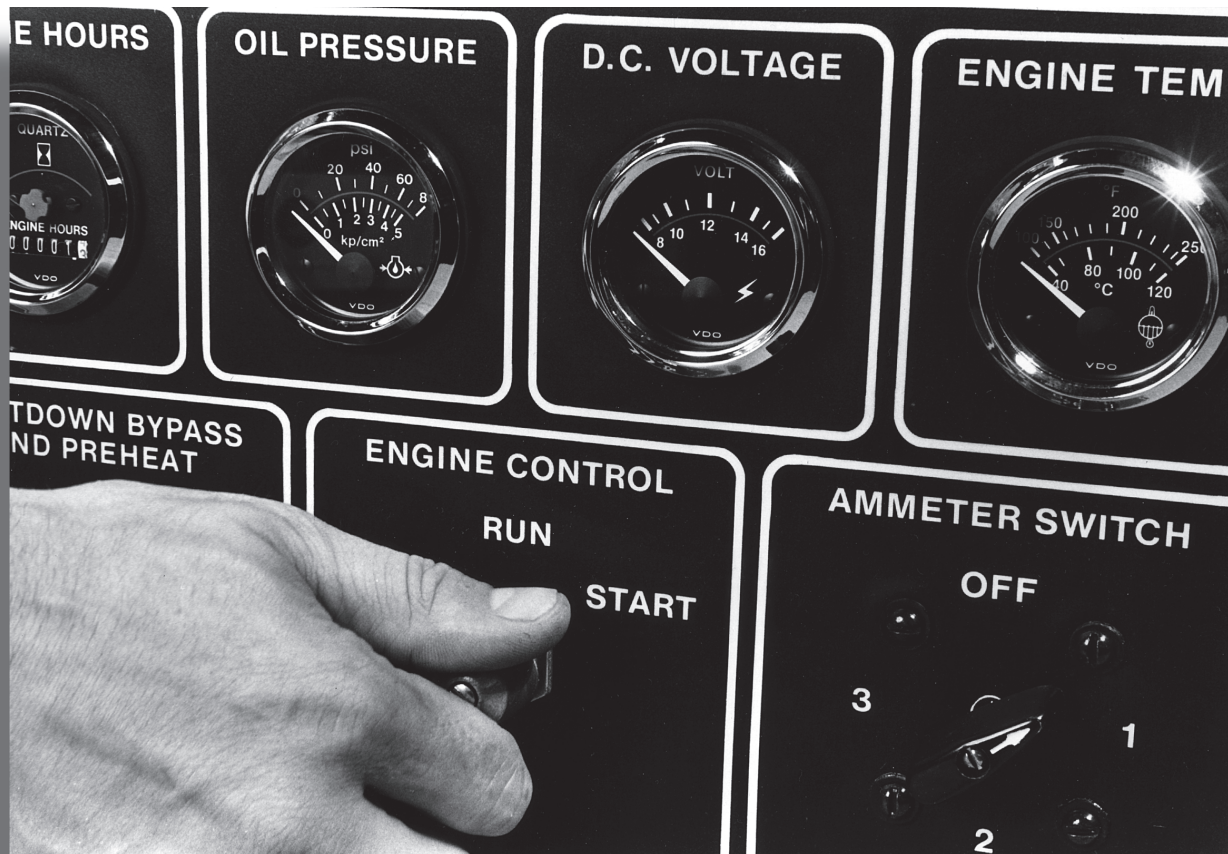

**NORTHERN LIGHTS**



— CALIFORNIA —  
Proposition 65 Warning:

*Diesel engine exhaust and some of its constituents  
are known to the State of California to cause  
cancer, birth defects, and other reproductive harm.*



**Northern Lights**

4420 14th Avenue N.W.  
P.O. Box 70543  
Seattle, WA 98107  
Tel: (206) 789-3880  
Fax: (206) 782-5455

Copyright ©2003 Alaska Diesel Electric, Inc.  
All rights reserved. Northern Lights™, and  
the Northern Lights logo are trademarks of  
Alaska Diesel Electric, Inc.

Printed in U.S.A.  
PART NO.: 0843K 05/03

# OPERATOR'S MANUAL

for Models  
M843JK, M843NK, and NL843NK

*Read this operator's manual thoroughly before starting to operate your equipment.  
This manual contains information you will need to run and service your new unit.*

## Table of Contents

<b>INTRODUCTION</b> .....	<b>2</b>	<b>SERVICING (continued)</b>	
Models Included .....	<b>2</b>	V-Belts .....	<b>13</b>
Model Numbers .....	<b>2</b>	Retightening Cylinder Head Bolts .....	<b>13</b>
Serial Numbers .....	<b>3</b>	Valve Clearances .....	<b>13</b>
<b>WARRANTY</b> .....	<b>3</b>	Fuels - General .....	<b>14</b>
<b>SAFETY RULES</b> .....	<b>3</b>	Fuel Filters .....	<b>14</b>
<b>COMPONENT LOCATIONS</b>		Bleeding the Fuel System .....	<b>15</b>
M843JK and M843NK Marine Generator .....	<b>4</b>	Injector Service .....	<b>16 - 17</b>
NL843NK Industrial Generator .....	<b>5</b>	Injection Pump .....	<b>17</b>
<b>CONTROL PANELS</b>		Cooling System - General .....	<b>17</b>
Northern Lights Generator Sets .....	<b>6 - 7</b>	Cooling System Flushing .....	<b>18</b>
<b>OPERATING PROCEDURES</b>		Heat Exchanger (Marine) .....	<b>18</b>
Break-in Period .....	<b>8</b>	Raw Water Pump .....	<b>18</b>
Before Starting .....	<b>8</b>	Generator Ends .....	<b>18</b>
Starting .....	<b>8</b>	Electrical System - General .....	<b>18</b>
Operating .....	<b>8</b>	Glow Plugs .....	<b>19</b>
Stopping .....	<b>8</b>	Booster Batteries .....	<b>19</b>
Shutdowns and Alarms .....	<b>9</b>	Battery Care .....	<b>19</b>
Spare Parts .....	<b>9</b>	PTO Care .....	<b>19</b>
<b>SERVICING SCHEDULE CHART</b> .....	<b>10 - 11</b>	Winterizing / Out-of-Service .....	<b>19</b>
<b>SERVICING</b>		Exhaust Elbow .....	<b>19</b>
Lubrication - General .....	<b>12</b>	<b>TROUBLESHOOTING</b>	
Checking Oil .....	<b>12</b>	Electrical .....	<b>20</b>
Oil Changes .....	<b>12</b>	Engine .....	<b>21 - 23</b>
Changing Oil Filter .....	<b>12</b>	<b>DATA SHEETS</b>	
Air Filter .....	<b>13</b>	M843JK .....	<b>24</b>
		M843NK .....	<b>25</b>
		<b>WIRING DIAGRAMS</b>	
		DC Electrical .....	<b>26 - 27</b>

### Proprietary Information

This publication is the property of Alaska Diesel Electric, Inc.

It may not be reproduced in whole or in part without the written permission of Alaska Diesel Electric, Inc.

© Alaska Diesel Electric, Inc. All rights reserved. Litho U.S.A. Publication number O843K 05/03

## Introduction

Servicing of marine engines and generator sets presents unique problems. In many cases boats cannot be moved to a repair facility. Marine engines cannot be compared to the servicing of automobiles, trucks or even farm equipment. Failures often occur in remote areas far from competent assistance. Marine engines are taxed far more severely than auto or truck engines; therefore, maintenance schedules must be adhered to more strictly.

Failures can begin with minor problems that are overlooked and become amplified when not corrected during routine maintenance.

As operator, it is your obligation to learn about your equipment and its proper maintenance. This is not a comprehensive technical service manual. Nor will it make the reader into an expert mechanic. Its aim is to aid you in maintaining your unit properly.

## Unit Identification

### MODELS INCLUDED

This manual covers the operating instructions for:

- M843JK** marine generator sets,
- M843NK** marine generator sets, and
- NL843NK** industrial generator sets.

Fill in the model number of your unit in the blank space provided.

This will give you a reference whenever service or maintenance is required:

My Northern Lights generator set MODEL number is:

## Model Numbers

Model numbers give the unit's application, block model, aspiration, and RPM:

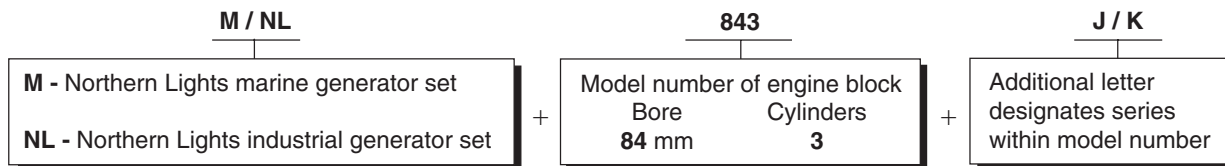

**M843JK** = Northern Lights marine diesel generator set with a J-series 843 engine and a PX-300K generator end with an AVR.

**NL843NK** = Northern Lights industrial generator set with an N-series 843 engine, PX-300K generator with an AVR, and a radiator.

**M843NK** = Northern Lights marine diesel generator set with an N-series 843 engine and a PX-300K generator end.

## Serial Numbers

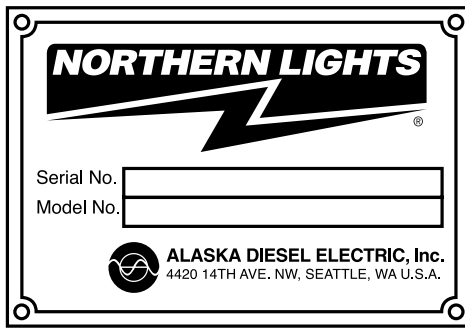

Figure 1: Generator set serial number plate.

Your set has three serial numbers: ① an engine number stamped on the block, ② a generator plate, and ③ a generator set plate.

Use the serial number on the generator set plate when ordering parts or in correspondence. The generator set plate is found on the service side of the generator and resembles the drawing in Figure 1.

Fill in the serial number of your unit in the box provided.

My Northern Lights generator set SERIAL number is:

## Warranty

A warranty registration certificate is supplied with your set. It entitles the original purchaser of our equipment to a warranty covering material or assembly faults. The extent of coverage is described in the Limited Warranty Statement. We recommend that you study the statement carefully.

**NOTE:** If the warranty is to apply, the servicing instructions outlined in this manual must be followed. If further information is needed, please contact an authorized dealer or the factory.

## Safety Rules



**CAUTION:** Accident reports show that careless use of engines causes a high percentage of accidents.

You can avoid accidents by observing these safety rules. Study these rules carefully and enforce them on the job.

- Never leave engine without proper security.
- Turn the coolant tank cap slowly to relieve pressure before removing. Add coolant only when the engine is stopped and cool.
- Mount a fire extinguisher near engine.
- Always disconnect the battery ground strap before making adjustments.
- Operate engines in properly ventilated areas.
- Keep trash and other objects away from engine.
- Escaping fluids under pressure can penetrate your skin. Use a piece of cardboard or wood, not your hands, to search for leaks.
- Avoid wearing loose clothing without a belt when working around engines.
- Do not oil or grease engine while it is running.
- Use caution in handling fuel. Never refuel a hot or running engine. Do not smoke while filling fuel tank or servicing fuel system.
- Keep your hands, feet, hair and clothing away from power-driven parts.
- Check for any loose electrical connections or faulty wiring.
- Engines should be operated only by knowledgeable, qualified personnel.
- Look completely around engine to make sure that everything is clear before starting.
- Do not operate an engine that isn't in proper working order. If an unsafe operating condition is noted, tag the set and control panel so others will also know about the problem.
- Provide first aid kits.



**CAUTION:** This symbol is used throughout this book to alert you to possible danger areas. Please take special notice of these sections.

## Marine Generator Component Locations

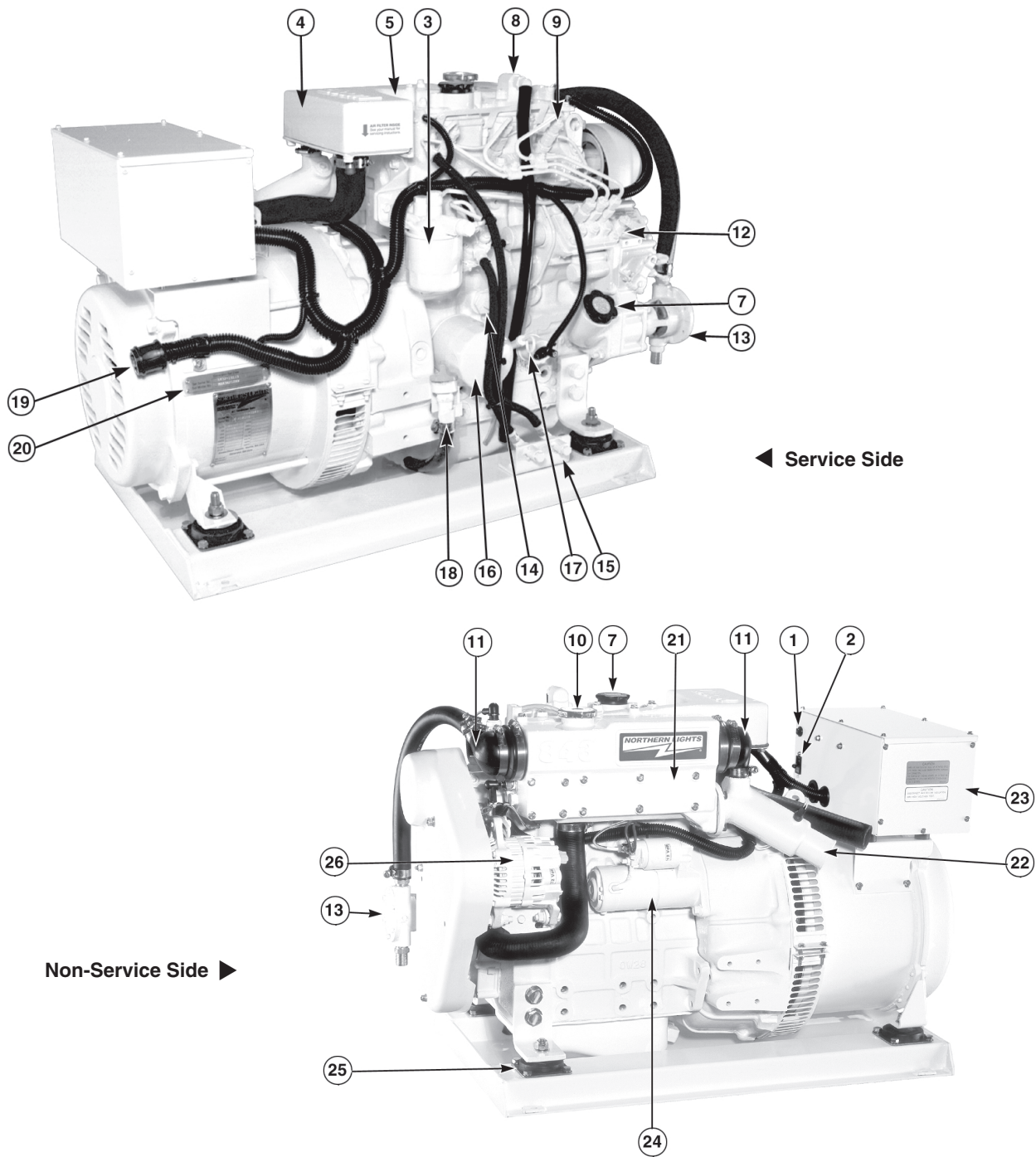

Figure 2: M843JK, M843NK, service and non-service views

- |                                 |                            |                           |                       |
|---------------------------------|----------------------------|---------------------------|-----------------------|
| 1. DC Circuit Breaker           | 8. Crankcase Vent          | 15. Fuel Inlet & Return   | 22. Wet Exhaust Elbow |
| 2. AC Circuit Breaker for AVR   | 9. Fuel Injector           | 16. Oil Filter            | 23. Junction Box      |
| 3. Fuel Filter                  | 10. Coolant Fill           | 17. Oil Dipstick          | 24. Starter           |
| 4. Air Filter (inside Manifold) | 11. Heat Exchanger End Cap | 18. Oil Drain             | 25. Vibration Mount   |
| 5. Intake Manifold              | 12. Injection Pump         | 19. Control Panel Plug-In | 26. DC Alternator     |
| 6. Fuel Lift Pump               | 13. Seawater Pump          | 20. Generator Set Plate   |                       |
| 7. Oil Fill (2)                 | 14. Freshwater Block Drain | 21. Expansion Tank        |                       |

## Industrial Generator Set Component Locations

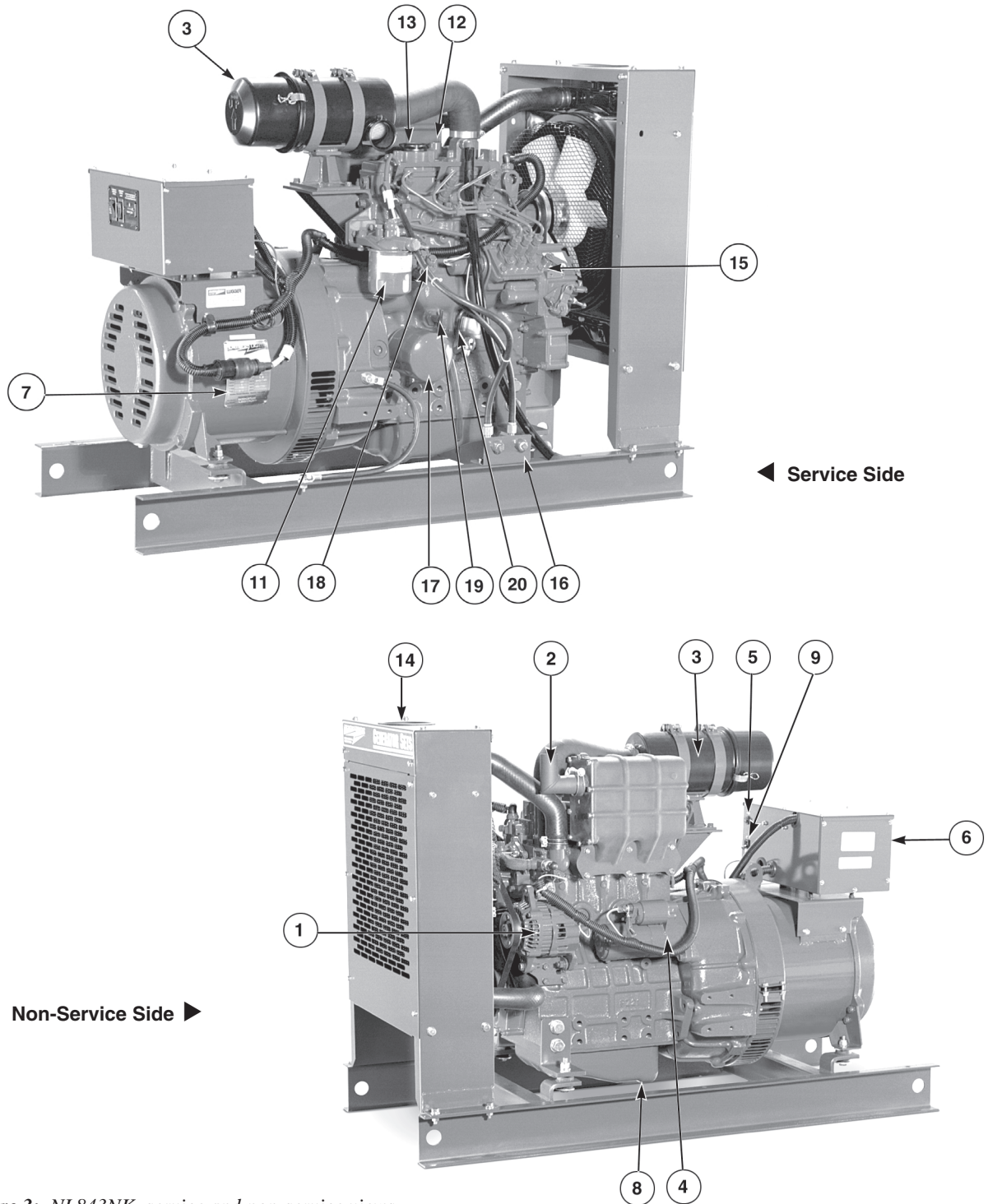

Figure 3: NL843NK, service and non-service views

- |                           |                           |                           |
|---------------------------|---------------------------|---------------------------|
| 1. DC Alternator          | 8. Lube Oil Drain         | 16. Fuel Inlet and Return |
| 2. Exhaust Outlet         | 9. AC Circuit Breaker     | 17. Oil Filter            |
| 3. Air Filter             | 11. Secondary Fuel Filter | 18. Fuel Lift Pump        |
| 4. Starter                | 12. Crankcase Vent        | 19. Block Water Drain     |
| 5. DC Circuit Breaker     | 13. Lube Oil Fill         | 20. Dipstick              |
| 6. Generator Junction Box | 14. Coolant Fill          |                           |
| 7. Starter                | 15. Injection Pump        |                           |

# Control Panels

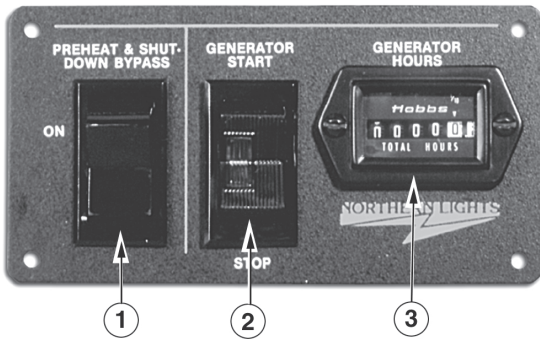

Figure 4-A: Series 1-B Generator Control Panel

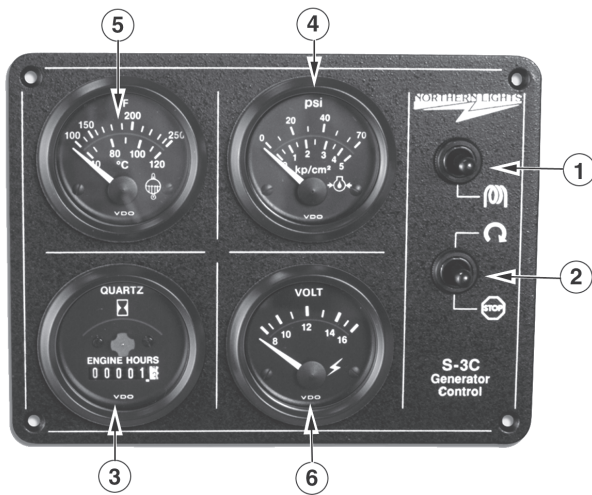

Figure 4-B: Series 3 Generator Control Panel

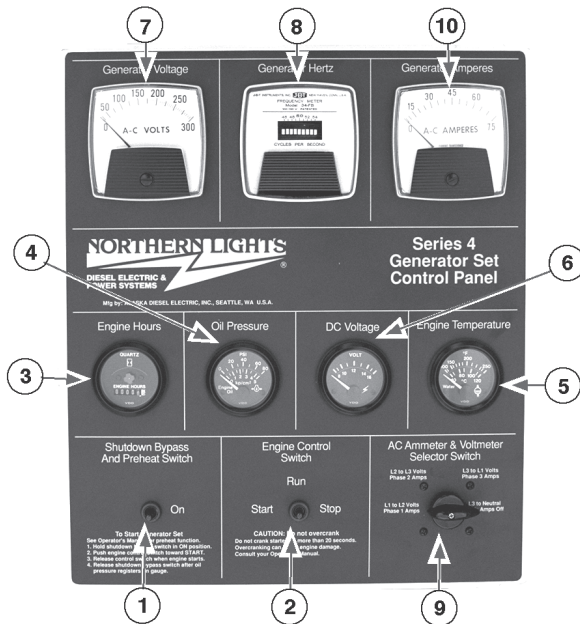

Figure 4-C: Series 4 Generator Control Panel

## 1. SHUTDOWN BYPASS-PREHEAT SWITCH

Two functions are built into this switch: the preheating of the engine, and bypassing of the engine safety shutdown circuit. Hold switch in the ON position 10 - 20 seconds before starting the engine, and continue holding on during engine cranking. Release the switch as soon as the engine is running. Holding the switch on too long can burn out the heater element.

## 2. ENGINE CONTROL SWITCH

To start the engine, hold this switch in the START position until the engine is running.

*NOTE: Excessive cranking of marine sets equipped with water lift muffler systems can cause engine damage. See page 10.*

After the engine starts, release the switch and it will return to RUN position. To stop the engine, hold the switch in the STOP position until the engine has completely stopped.

*NOTE: The rocker switch is used on Series 1 panels only, and has a light that glows when the set is running.*

## 3. HOUR METER

Keeps track of engine running time.

## 4. OIL PRESSURE GAUGE

Shows the oil pressure in the engine lubricating system.

## 5. ENGINE TEMPERATURE GAUGE

Registers the temperature of the engine coolant.

## 6. D.C. VOLTMETER OR AMMETER

When the engine is stopped, the voltmeter indicates the condition of the battery. When the engine is running, the voltmeter indicates the voltage output of the alternator.

## For Series 4 Control Panels Only:

## 7. A.C. VOLTMETER

Shows the generator output voltage.

## 8. FREQUENCY METER (Hertz)

The frequency meter indicates alternating current frequency: 60 Hz (1800 RPM), or 50 Hz (1500 RPM).

## 9. AMMETER/VOLTMETER SELECTOR SWITCH

Used to check voltage and current of each phase.

## 10. A.C. AMMETER

Shows the generator load on each phase. The phase is selected with the Ammeter Selector switch (Item 9).



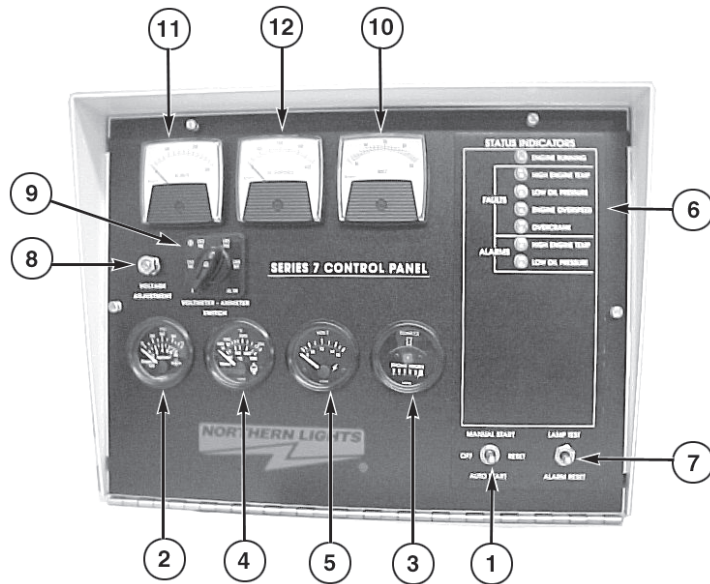

**Figure 5:** Series 7.0 through Series 7.6 Generator Control Panels

## 1. SHUTDOWN BYPASS SWITCH

Manual Start Panels

(S-7.1 and S-7.3)

Hold the switch in the START position until the engine is running

*NOTE: Excessive cranking may cause engine damage.*

After the engine starts, release the switch and it will return to the RUN position. To stop the engine, hold the switch in the STOP position.

Auto Start Panels

(S-7.0, S-7.2, S-7.4, S-7.5, and S-7.6)

After the engine starts, release the switch and it will return to the RUN position. To stop the engine, hold the switch in the STOP position.

## 2. OIL PRESSURE GAUGE

Shows the oil pressure in the engine lubricating system.

## 3. HOUR METER

Keeps track of engine running time.

## 4. ENGINE TEMPERATURE GAUGE

Registers the temperature of the coolant.

## 5. DC VOLTMETER

When the engine is running, the voltmeter indicates the voltage output of the alternator.

## 6. STATUS INDICATOR PANEL

Engine monitoring alarms and lamps for monitoring engine functions.

## 7. ALARM LAMP TEST AND RESET BUTTON

Press UP to test the indicator lights and press DOWN to reset the alarm.

## 8. AC VOLTAGE ADJUSTMENT RHEOSTAT

Voltage has been set at the factory and should only be adjusted by factory-trained personnel.

## 9. AMMETER SELECTOR SWITCH

Used to check each phase for load condition.

*NOTE: Always leave this switch in the ON position while the unit is running.*

## 10. FREQUENCY METER (HERTZ)

The frequency meter indicates alternator current frequency: 60 Hz (1200 or 1800 RPM), or 50 Hz (1500 RPM).

## 11. A.C. VOLTMETER

Shows the generator output voltage.

## 12. A.C. AMMETER

Shows the generator load on each phase. The phase is selected with the Ammeter Selector switch.

## Operating Procedures

### BREAK-IN PERIOD

1. The first 100 hours on a new or reconditioned engine are critical to its life and performance.
2. Frequently check the engine temperature and oil pressure gauges (sets with Series 3 or 4 panels).
3. Oil consumption is greater during break-in as piston rings take time to seat.
4. Break-In Oil Changes: Change engine oil and filter at 50 hours. Change oil and filter again at 100 hours (consult Lubricants section for oil recommendation).
5. Retighten head bolts at 50 hours (see page 13).

#### Operating Instructions:

Maintain at least a 75% load on your generator set for the first 100 hours. If this is not possible, maintain no less than a 50% load to ensure proper seating of the piston rings. Vary the load to help seat the rings.

### BEFORE STARTING

1. Check the water level by removing the pressure cap from the expansion tank or radiator. In order to give the cooling water an opportunity to expand, the level should be about 1 in. (2.5 cm) below the filler cap sealing surface when the engine is cold.



**CAUTION:** Use protective clothing and open the filler cap carefully when the engine is warm to prevent burns.

2. Check the oil level in the crankcase with the dipstick. The oil level must be in the waffled area on the stick. Never allow the level to go below this area. Always add the same viscosity of oil as is already in the crankcase.
3. Check the fuel tank level and open any fuel valves.
4. Marine Sets: close the sea-cock; check, clean, and reassemble the sea strainer and reopen the sea-cock.
5. Marine Sets: place the battery switch in the ON position.
6. **NOTE:** The battery switch must always be kept ON while the engine is running. If the switch is turned OFF while the engine is running, the battery charging regulator could be ruined.

### STARTING

1. Hold the Shutdown Bypass-Preheat switch in the ON position for 10 to 20 seconds before starting a cold engine. Holding the switch too long can burn out the glow plugs. This step is not necessary if the engine is already warm.
2. While holding the Shutdown Bypass-Preheat switch in the ON position, push the Engine Control switch to the START position.
3. As soon as the engine starts, release both switches. Do not crank the starter for more than 20 seconds consecutively. If the engine fails to start with the first attempt, be sure that it has stopped completely before re-engaging.
6. **NOTE:** Excessive cranking of the starter on Marine sets equipped with a water lift muffler can cause engine damage. If the engine does not start after three 20-second cranks, remove the impeller from the raw water pump. This will prevent the muffler from filling with water and backfilling the exhaust line and engine. Once the engine starts, shut it off immediately and re-install the impeller. Re-start the engine and check the exhaust overboard outlet for gushes of water.

### OPERATING

1. Units with Series 3 and Series 4 Control Panels: check gauges often. Oil pressure must be above 15 PSI. The D.C. voltmeter should read between 11 and 15 volts at 80°F (25°C) ambient temperature. The water temperature gauge on Marine sets must be below 200°F (94°C); on Industrial units the water temperature gauge must be below 225°F (107°C). Check the A.C. voltage and frequency meters (Series 4 panel). If the gauges deviate from normal levels, shut down the generator set and investigate.
2. Let the unit run unloaded for a three to five minute warm-up period.
3. Apply electrical load.

### STOPPING

1. Remove electrical load from the generator set.
2. Run the engine for a 3 to 5 minute cool down period.
3. Hold the Engine Control switch to the STOP position until the engine comes to a complete stop.
4. Marine Sets: shut off the seacock, fuel valve, and battery switch.

### SHUTDOWNS AND ALARMS

1. Your unit is fitted with a system to protect it from high water temperature or low oil pressure.
  - a. Generator sets have shutdown systems to stop the engine. They have no warning horns.
  - b. Other alarms and shutdowns are available as optional equipment.

**NOTE:** *Do not rely on your warning to the exclusion of careful gauge monitoring. Watching your gauges can prevent damage to the unit and dangerous power losses.*

2. Do the following when your warning or shutdown system is activated:
  - a. Check the temperature gauge.
 

**Marine sets:** If above 205°F (96°C), shut off the engine immediately.

**Industrial sets:** If above 230°F (110°C) shut off the engine immediately.
  - b. Use the Trouble Shooting Guide on page 22 to isolate the cause of the overheat.



**CAUTION:** *Do not remove the water fill cap of an overheated engine. Escaping high temperature steam can cause severe burns. Allow the engine to cool and then remove the cap slowly using protective clothing.*

- d. Make repairs. Restart your Marine set after the temperature gauge registers below 200°F (94°C).
- e. Watch the temperature gauge regularly and turn off the unit if the temperature rises above 205°F (96°C) on Marine units. Repeat troubleshooting.
3. If shutdown is activated and the temperature gauge shows temperature within normal temperature range:
  - a. Check the engine crankcase oil level.
  - b. If the oil level is low, fill with recommended lubricating oil and restart. Watch the oil pressure gauge carefully and shut off the engine if it does not show a normal reading (20-60 PSI) after a few seconds of operation.
  - c. If the oil level is normal, DO NOT restart the engine. Call your dealer for assistance.

### SPARE PARTS

1. ADE recommends that you keep the following spare parts on hand for field service. The parts are available from your local Northern Lights dealer. Some marine models already have “On-Board-Kits,” a handy box that contains the most common parts you will need.
2. All owners should have the following spares:
  - a. Primary and secondary fuel filter elements
  - b. Oil filters
  - c. Air filter
  - d. Alternator belt
  - e. Thermostat and gaskets
  - f. Seawater pump impeller & gaskets (marine only)
  - g. Glow plug
  - h. Injector and washer
3. If your set is operating a long distance from a servicing dealer, add the following:
  - a. Complete set of injectors
  - b. Copper washers for injector change
  - c. Complete set of glow plugs
  - d. Fuel lift pump

## Servicing Schedule Chart

The Servicing Schedule Chart below shows the service schedule required for proper maintenance of your generator set. More detailed coverage of each Service Point (SP) is listed on the page noted in the 'page' column.

**DAILY:**

- SP1 Check oil level in engine
- SP7 Check primary fuel filter
- SP13 Check cooling water level  
Check sea strainer (marine only)  
Check raw water pump for leaks

**AFTER FIRST 50 HOURS:**

- SP2/3 Change engine oil and filter
- SP5 Check V-belt tension
- SP6 Adjust valves
- SP18 Check electrolyte in batteries  
Retighten head bolts (see page 11)

**EVERY 50 HOURS:**

- SP5 Check V-belt tension
- SP18 Check electrolyte in batteries

**EVERY 100 HOURS:**

- SP16 Check and clean radiator (industrial only)

**EVERY 200 HOURS:**

- SP2/3 Change engine oil and filter
- SP4 Check air cleaner
- SP8 Change primary fuel filter element
- SP9 Change secondary fuel filter

**EVERY 600 HOURS:**

- SP6 Check valve clearances
- SP11 Check injectors
- SP14 Check and flush cooling system
- SP17 Change impeller (marine only)
- SP19 Check state of charge of batteries

**EVERY 2400 HOURS:**

- SP12 Check fuel injection pump
- SP15 Check and clean heat exchanger (marine only)

SERVICE POINT	PAGE	OPERATION	DAILY	50 Hours	100 Hours	200 Hours	600 Hours	2400 Hours
<b>ENGINE:</b>								
SP1	8 & 12	Check oil level	●					
SP2	12	Change engine oil 1)		5)		●		
SP3	12	Change lube oil filters 1)		5)	●			
SP4	12	Check air cleaner 1) 4)				●		
SP5	12	Check V-belt tension 1) 4)		●				
SP6	13	Check valve clearances 1) 2)		5)			●	
<b>FUEL SYSTEM:</b>								
SP7	14	Check primary filter (Racor) 2) 3)	●					
SP8	14	Change primary filter element (Racor) 2) 3)				●		
SP9	14	Change secondary fuel filter 1) 3)				●		
SP10	15	Bleed the fuel system 3)						
SP11	16 - 17	Check injectors 1) 3)					●	
SP12	17	Check fuel injection pump						●
<b>COOLING SYSTEM:</b>								
SP13	8 & 17	Check cooling water level	●					
SP14	17 - 18	Check and flush cooling system					●	
SP15	18	Check and clean heat exchanger (Marine)						●
SP16	-	Check and clean radiator fins (Industrial)			●			
SP17	18	Change impeller in raw water pump 1) 3)					●	
SP21		Inspect condition of exhaust elbow 4)				●		
<b>ELECTRICAL SYSTEM:</b>								
SP18	19	Check electrolyte level in batteries 1) 4)		●				
SP19	19	Check condition of batteries with hydrometer 1) 4)					●	
<b>DRIVEN EQUIPMENT:</b>								
SP20	19	Clutch and PTO service (M843NK only) 2)						
<b>OUT OF SERVICE:</b>								
SP21	19	Winterizing or out-of-service 3)						

1) Perform all maintenance once a year even if hour level has not been reached.  
 2) Consult manufacturer's maintenance schedule, note on chart.  
 3) Whenever necessary.

4) More often if necessary.  
 5) After first 50 hours.

## Service Record

Service Point	OPERATION	HOURS/DATE							
<b>50 HOURS</b>									
SP5	Check V-belt tension								
SP18	Check electrolyte in batteries								
<b>100 HOURS</b>									
SP3	Change lubricating oil filters								
SP4	Check air cleaner								
SP16	Check and clean radiator								
<b>EVERY 200 HOURS</b>									
SP2	Change engine oil and filter								
SP8	Change primary filter element (Racor)								
SP9	Change secondary fuel filter								
SP21	Inspect condition of exhaust elbow								
<b>EVERY 600 HOURS</b>									
SP6	Check valve clearances								
SP11	Check injectors								
SP14	Check and flush cooling system								
SP17	Change impeller in raw water pump								
SP19	Check condition of batteries with hydrometer								
<b>2400 HOURS</b>									
SP12	Check fuel injection pump								
SP15	Check and clean heat exchanger								

## Servicing

### LUBRICATION - GENERAL

1. Use only clean, high quality lubricants stored in clean containers in a protected area.
2. These lubricants are acceptable:
  - a. API Service CC/CD/CE single viscosity oils.
  - b. API Service CC/CD/SF multi-viscosity oils.
3. Use the proper weight oil for your average operation temperature.

Air Temperature	Single Viscosity	Multi-Viscosity
Above 32°F (0°C)	SAE 30W	SAE 15-40W
-10 to 32°F (-23 to 0°C)	SAE 10W	SAE 10-30W
Below -10°F (-23°C)	SAE 5W	SAE 5-20W

Figure 6: Lube Oils

4. Some increase in oil consumption may be expected when SAE 5W and SAE 5-20W oils are used. Check oil level frequently.
5. Never put additives or flushing oil in crankcase.

### SP1. CHECKING OIL LEVEL

1. Check the oil level in the crankcase with the dipstick. The oil level must be in the waffled area on the stick. Never allow the level to go below this area. Follow the lubrication recommendations above.

### SP2. OIL CHANGES

1. The set is delivered with special break-in oil. Change the engine oil and oil filter after 50 hours of operation. Use Service CC 30 weight oil during the first 100 hours.
2. Change the oil and filter again at 100 hours using the oil recommended in the above diagram. After this, change oil and filter every 200 hours.
3. During intermittent cold weather operation, change oil every 100 hours or six weeks, whichever comes first.
4. Change oil at the end of each season and the beginning of each season.
5. Change oil when engine is warm.
6. Dispose of waste oil in an approved manner.
7. Never use a flushing oil.
8. Loosen the clamp on the oil change tube. Remove cap. Drain oil. Replace the cap and tube.
9. Refill engine with recommended oil for the season.
10. Engine capacity with new oil filter is:  
**843JK and 843NK – 5.8 quarts (5.5 liters)**

### SP3. CHANGING LUBE OIL FILTER

1. Change the lube oil filter every 200 hours.
2. Use a filter wrench to remove old filter. Dispose of filter in approved manner.
3. Make sure the gasket from the old filter is removed and discarded. Clean mount face.
4. Spread a thin film of engine oil on the rubber gasket on the new filter and screw it on nipple until gasket meets the sealing surface.
5. Using hands only – no wrench – tighten filter one-half turn farther. Overtightening can do damage to filter housing.
6. Fill engine with recommended oil. Start engine and check for leakage. Stop engine, wait 3 minutes, and check oil level. Add additional oil if necessary.
7. Oil filter part number is:  
**843JK and 843NK – #24-03100**

**SP4. AIR CLEANER**

1. Inspect air cleaner every 200 hours. In dusty conditions, check more often.
2. Marine sets: if dirty, wash element in soapy water. Rinse and dry thoroughly before re-installing. Replace if necessary. Part numbers are:  
**M843JK and M843NK – #24-23100**
3. Industrial sets: the element cannot be cleaned. Replace it when necessary. Part number is:  
**NL843NK – #314531127**
4. *NOTE: Make absolutely sure no impurities enter the engine while changing the element. Do NOT run the engine with the air cleaner removed.*

**SP5. V-BELTS**

1. Check the tension and wear on the V-belt after every 50 hours.
2. Use your thumb to press on the belt at the midpoint between the crankshaft and alternator pulleys. The tension is correct if the belt can be depressed about 3/16 in. (5 mm).

**RETIGHTENING CYLINDER HEAD BOLTS**

1. Tighten bolts when the engine is cold.
2. Loosen the nuts and remove rocker arm cover.
3. Tighten head bolts with a torque wrench in the order shown in figures below. Tighten bolts evenly in 2 or 3 passes, ending at the specified torque in final pass.  
**843JK & 843NK: 60 - 64 ft/lbs (9.0 - 9.5 kg/m)**

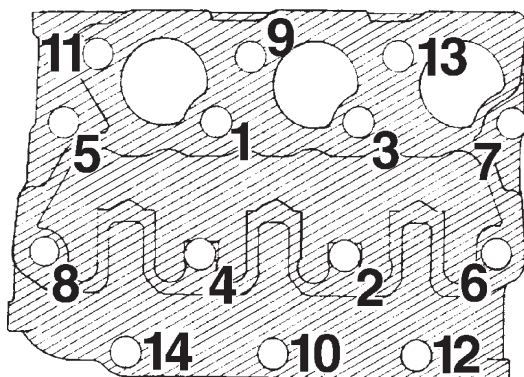

Figure 7: 843N Head Torque Sequence

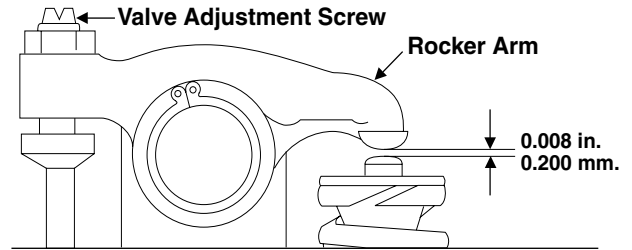

Figure 8: Valve Adjustment

**SP6. VALVE CLEARANCES**

1. Adjust valve clearance after first 50 hours of operation and every 600 hours thereafter.
2. Valve adjustments should be done after the cylinder head bolts have been re-tightened. Engine should be cold and NOT running.
3. Watch the valves while turning the engine over by hand. Turn until the inlet valve starts to open and the exhaust valve starts to close (the valves are rocking). Then turn the crankshaft one more full turn and adjust the clearance on both valves for this cylinder.
4. Loosen the lock nut and adjust the clearance between the rocker arm and valve guide of both the intake and exhaust valves with the adjustment screw (Figure 8). Clearance on both intake and exhaust valves should be 0.008 in. (0.2 mm).
5. Repeat steps 3 and 4 for each cylinder. Each set of valves must be adjusted individually.
6. Replace the rocker arm cover. Tighten cover nuts to 5 - 8 ft/lbs (0.8 - 2.3 kg/m).

### FUELS - GENERAL

1. Use only clean, high quality fuels of the following specifications, as defined by ASTM designation D975 for diesel fuels:
  - a. Use grade no. 2 diesel at ambient temperatures above freezing 32°F (0°C).
  - b. Use grade no. 1 at ambient temperatures below freezing and for all temperatures at an altitude of above 5,500 ft. (1500 meters).
2. Use fuel having less than 1% sulphur (preferably less than 0.5%).
3. The cetane number should be a minimum of 45.
4. DO NOT use these unsuitable grades of fuel:
  - a. Domestic heating oils, all types.
  - b. Class B engine.
  - c. Class D domestic fuels.
  - d. Class E, F, G or H industrial or marine fuels.
  - e. ASTM-D975-60T No. 4-D and higher number fuels.
5. Storing fuel:
  - a. Keep dirt, scale, water, and other foreign matter out of fuel.
  - b. Avoid storing fuel for long periods of time.
  - c. Fill the fuel tank at the end of each day's operation. This will reduce condensation and possible biological contamination.
  - d. If biological contamination is detected or suspected, contact your dealer for assistance.

### SP7-9. FUEL FILTERS

1. Your generator set should have a primary fuel filter installed. We recommend the Racor brand of fuel filter-water separators.
  - a. Check the primary fuel filter daily as recommended by the filter manufacturer. Empty the collection bowl as necessary.
  - b. Change the element as often as necessary or every 200 hours.
  - c. If the bowl fills with water, change the primary and secondary element immediately.
2. Change secondary fuel filter every 200 hours.

*NOTE: The fuel filter on the engine is considered the "secondary fuel filter."*

  - a. Remove the spin-on filter by turning it counterclockwise with a filter wrench. Fill the new cartridge with fuel and install it after applying engine oil to gasket surface. Screw on until the gasket surface comes into contact with sealing surface of filter base. Then, tighten it two-thirds of a turn by hand. Do not overtighten.
  - b. Fuel filter part numbers are:  
**843JK and 843NK – #130336020**



## SP10. BLEEDING THE FUEL SYSTEM



**CAUTION:** Escaping diesel fuel under pressure can penetrate skin causing serious personal injury. Before disconnecting lines be sure to relieve all pressure. Before applying pressure, be sure all connections are tight and lines, pipes and hoses aren't damaged. Fuel escaping from a very small hole can be almost invisible. Use a piece of cardboard or wood, rather than hands, to search for suspected leaks. If injured by escaping fuel, see a doctor at once. Serious infection or reaction can develop if proper medical treatment isn't administered immediately.

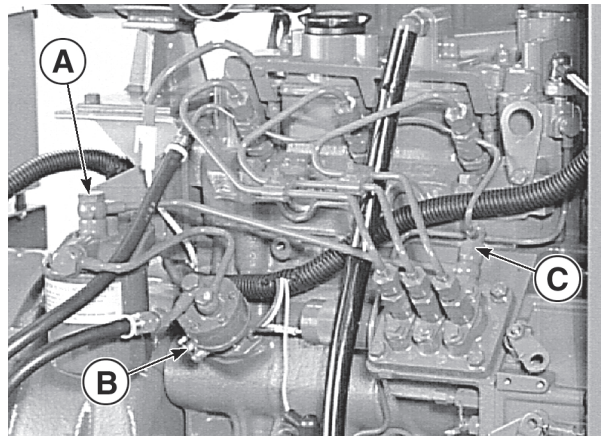
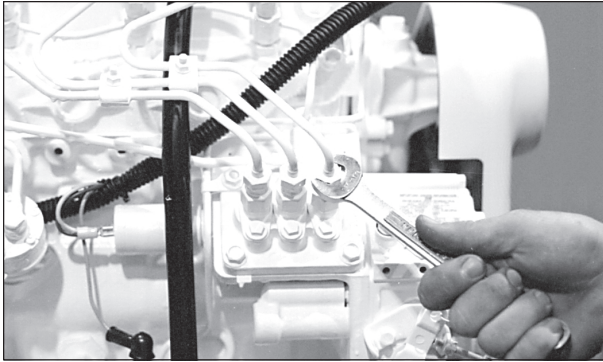

Figure 9: NL843NK Fuel System.

1. The fuel system is self-bleeding. However, any system may need manual bleeding when:
  - a. A new fuel filter is installed;
  - b. The engine has run out of fuel;
  - c. The fuel lines, injection pump or any other fuel system component has been removed and installed.
2. Loosen bleed bolt "A" (Figure 9) on top of the filter. Pump hand primer "B" on fuel lift pump until pure fuel (no bubbles) escapes from bleed bolt "A". Tighten bleed screw "A".
3. Loosen bleed screw "C". Pump hand primer "B" until pure fuel (no bubbles) escapes. Then tighten bleed screw "C".
4. If the engine does not start after the above bleeding process, loosen a fuel line at the injector while cranking the engine with the starter motor until pure fuel escapes. Then tighten the connection. Do each line **one-at-a-time**.
5. After the engine has started, use a piece of cardboard to look for fuel leaks.

## Servicing



**Figure 10:** Remove delivery line flare nuts.



**Figure 14:** Remove return line.

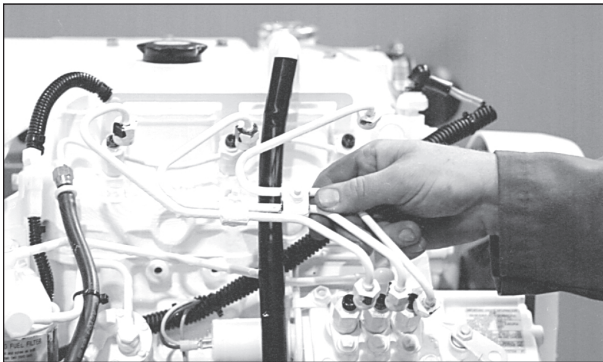

**Figure 11:** Remove delivery lines.

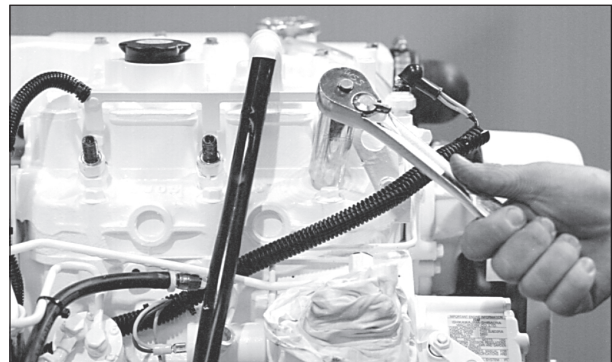

**Figure 15:** Unscrew injector.



**Figure 12:** Cover lines, inlets and injection pump outlets.



**Figure 16:** Remove and replace copper sealing washer.

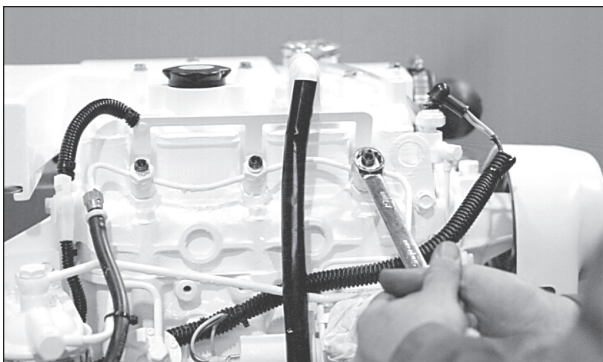

**Figure 13:** Remove return line nuts.



**Figure 17:** Reinstall injector. Torque to proper tightness.

## SP11. INJECTOR SERVICE

1. Injectors should be checked every 600 hours. Check should be made by a Northern Lights dealer or local injection repair station.



**CAUTION:** Escaping diesel fuel under pressure can have sufficient force to penetrate the skin causing serious personal injury. If injured by escaping diesel fuel, see a doctor at once.

### 2. Injector removal:

- a. Clean loose dirt from around the injectors and the fuel lines.
- b. Relieve high pressure in the fuel lines by loosening the delivery line flare nuts at each injector (Figure 10).
- c. Remove delivery lines by disconnecting from injectors and injection pump (Figure 11). Remove all lines as an assembly; do not remove the spacers. Cover the ends of the lines, the injector inlets and injection pump outlets to keep dirt out (Figure 12).
- d. Remove the return line retaining bolts (Figure 13). Remove the return line (Figure 14).
- e. Unscrew and remove the injectors (Figure 15).

**NOTE:** Do not use pry bars to remove injectors from cylinder head.

- f. After removing the injectors, discard the copper sealing washers from the injector hole in the head (Figure 16). Cover holes to prevent dirt and debris from entering the cylinders.

### 3. Injector installation:

- a. Install a new copper sealing washer in each injector hole (Figure 16).
  - b. Screw in injector and tighten to 44 - 51 ft/lbs (6 to 7 kgm) (Figure 17).
- NOTE:** Overtightening can damage injector.
- c. Install return line using a new sealing washer below each connection. Tighten return line retaining bolts to 22 - 30 ft/lbs.
  - d. Install delivery lines. Leave loose at injectors for bleeding.
  - e. Crank engine to fill lines. Tighten lines at injectors to 11-18 ft./lbs. Start engine and check for leaks using a piece of paper or cardboard.

**DO NOT use hand to check for leaks.**

## SP12. INJECTION PUMP

1. Since operating conditions may vary considerably, it is difficult to give a definite interval for checking the injection pump. But as a rule, pump settings, maximum speed, idle speed and exhaust smoke should be checked after every 2400 hours of operation. Service of the fuel injection pump should only be done if checks indicate pump malfunction.
2. Black smoke can be an indication of pump malfunction. Before servicing the pump, check other possible causes:
  - a. Check cleanliness of air filter.
  - b. Check valve clearances.
  - c. Clean and check injectors.
3. Any repair which involves disassembly of the injection pump must be carried out by specially trained mechanics with the proper tools and test equipment.

**NOTE:** All warranties on the engine become null and void if the injection pump seals are broken by unauthorized persons.

## COOLING SYSTEM - GENERAL

**NOTE:** Marine sets – be sure to close the sea-cock before working on the engine cooling system.



**CAUTION:** The cooling water in the engine reaches extremely high temperatures. You must use extreme caution when working on hot engines to avoid burns. Allow the engine to cool before working on the cooling system. Open the filler cap carefully, using protective clothing when the engine is warm.

## SP13. CHECK THE COOLANT LEVEL

1. Check the coolant level each day before starting the engine. Check the water level by removing the pressure cap from the expansion tank.  
In order to give the cooling water an opportunity to expand, the level should be about 1 in. (2.5 cm) below the filler cap sealing surface when the engine is cold.
2. The pressure valve in the filler cap releases when the pressure is approximately 7 PSI (0.5 bar). Use a cap pressure tester to check cap if you suspect it is faulty.

## Servicing

### SP14. COOLING SYSTEM FLUSHING

1. Flush the cooling system every 600 hours or every 12 months, whichever comes first.
2. Marine sets:
  - a. Remove expansion tank cap and drain engine block.
  - b. Open block drain cock. Remove hose from bottom of heat exchanger tank.
  - c. Pour clean water into expansion tank until water coming from drains is free of discoloration and sediment. Let water drain completely. Close drains and refill with recommended mixture.
3. Industrial sets:

Remove radiator cap and open drain cocks on radiator and engine block. Pour clean water into radiator until water coming from radiator is clear of discoloration. Close the radiator drain and continue flushing until water from engine drain is clear. Open all drain cocks and drain completely. Close drain cock and refill with recommended coolant mixture. Clean fins on radiator.
3. Coolant Specifications (marine and industrial):

Use 50% distilled water / 50% ethylene glycol antifreeze mix. Antifreeze mixture is recommended as a good year-round coolant.
4. Check hoses and connections and repair any leakage.

### SP15. HEAT EXCHANGER (Marine)

1. Clean the heat exchanger core once a year or after 2400 hours of operation.
2. Drain expansion tank and heat exchanger.
3. Remove heat exchanger end covers and remove core.
4. Clean the inside of exchanger core tubes using a metal rod. Flush, inspect and clean again if necessary.
5. Reassemble. Fill the cooling system, start the engine and check for leaks.

### SP16. CLEAN RADIATOR (Industrial)

1. Remove debris from radiator fins daily.
2. In very dusty applications, clean the radiator with compressed air or steam cleaner every 100 hours. Clean in the reverse direction of the airflow.

### SP17. RAW WATER PUMP (Marine)

1. Change the seawater pump impeller every 600 hours, or as needed.
2. Remove the pump end cover. Pry out the impeller using needle-nose pliers or two screwdrivers. Be sure you remove all pieces of failed impeller. **NOTE: Place some kind of protection under the screwdrivers in order not to damage the pump housing. If the impeller has broken into pieces, remove front heat exchanger end cover and inspect for impeller pieces. Clean inlet to heat exchanger bundle and reassemble.**
3. Clean the inside of the housing.
4. Press in the new impeller and place the sealing washers in the outer end of the impeller center if this has not already been done.
5. Replace the cover using a new gasket. **NOTE: Make sure that there is always an extra impeller and cover gasket in reserve on board.**

### GENERATOR ENDS

The maintenance and operation recommendations for the generator end are in a separate Owner's Manual. If you do not have one of these manuals, contact your local Northern Lights dealer.

### ELECTRICAL SYSTEM - GENERAL

1. Never switch battery switch off or break the circuit between the alternator and batteries while the engine is running. Regulator damage can result.
2. Do NOT reverse the polarity of battery cables when installing the battery.
3. If welding on the unit, disconnect the regulator and battery. Isolate the leads.
4. Disconnect the battery cables when servicing the D.C. alternator.
5. Never test with a screwdriver, etc., against any terminal to see if it emits sparks.
6. Do not polarize the alternator or regulator.
7. A D.C. circuit breaker protects your control panel and wiring harness. It is located in the side of the generator junction box.

## GLOW PLUGS

1. Each cylinder is supplied with a glow plug which serves to heat the combustion chamber.
2. To check the glow plugs, loosen the current carrying flat wire between the plus-poles of the glow plugs (Figure 18). Connect a D.C. test bulb between the plus-pole of the battery and the plus-pole of the glow plug. If the bulb lights up, the glow plug is functioning properly.
3. Check all glow plugs and replace any faulty ones.

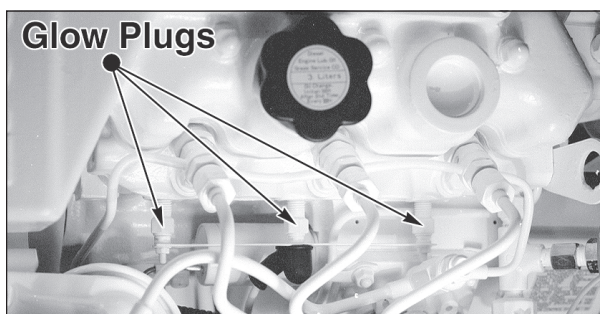

Figure 18: Glow plugs.

## BOOSTER BATTERIES



**CAUTION:** Battery gas can explode.

Keep all flames and sparks away from batteries.

1. Before changing or using booster batteries, check battery electrolyte level. Add distilled water if necessary.
2. Booster and main batteries must have the same voltage rating.
3. First, connect positive (+) terminal of booster battery to positive (+) terminal of main battery. Then, connect negative (-) terminal of booster battery to ground on the engine block (see Figure 19).
4. Remove booster battery after starting engine.
5. Sealed batteries: See manufacturer charging and booster instructions.

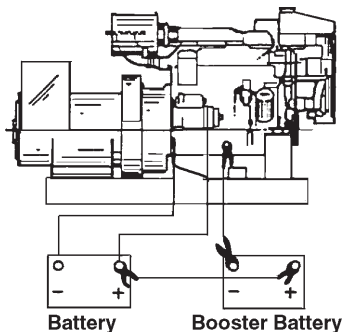

Figure 19:  
Battery connections.

## SP 18-19. BATTERY CARE

1. Check electrolyte level every 50 hours or once per month. Add distilled water to manufacturer's recommended level.
2. Batteries, cables and cable terminals should be checked and cleaned every 100 hours. Clean corrosion with a water and baking soda solution. Flush with clean water. Tighten terminals and grease them to inhibit corrosion.
3. Check the battery condition with a hydrometer every 600 hours.

## P.T.O.

1. The electric clutch P.T.O. does not have any scheduled maintenance points. However, the equipment the P.T.O. powers may require maintenance. Consult the manufacturer of the driven equipment.

## SP20. WINTERIZING / OUT-OF-SERVICE

1. Marine sets:
  - a. Drain fresh water and seawater cooling systems completely. Remember to shut off seacocks before opening drain cocks.
  - b. Drain water supply lines and wet exhaust line.
  - c. Loosen the seawater pump cover and drain pump.
2. Industrial sets:
  - a. Drain and flush the radiator and cooling system. Leave dry or refill with antifreeze-water mixture. If refilling, start the engine and run to circulate the antifreeze.
  - b. Fill the fuel tank or add biocide as per manufacturer's instructions.
  - c. Seal the air cleaner inlet, exhaust opening, crankcase breather pipe, and fuel tank vent with plastic bags and tape.
  - d. Store the set in a dry, protected place. If unit must be stored outside, be sure it is well protected with a cover.
3. Marine and Industrial sets:
  - a. Change the crankcase oil and filter.
  - b. Loosen the alternator belt.
  - c. Disconnect and clean battery. Remove to warm storage place if possible.
  - d. Clean outside of unit. Paint any scratched or chipped surfaces. Put corrosion preventative on all exposed metal surfaces.

## SP21. EXHAUST ELBOW

Look for external corrosion and signs of exhaust leakage.

## Troubleshooting

### DC ELECTRICAL SYSTEM

PROBLEM	POSSIBLE CAUSE	RECOMMENDATION(S)
<b>Battery Will Not Charge</b>	Loose or corroded connections	• Clean and tighten battery connections.
	Sulfated or worn out batteries	• Check specific gravity of each battery. • Check electrolyte level of each battery.
	Loose or defective alternator belt	• Adjust belt tension. • Replace belt.
<b>Starter Inoperative</b>	Check DC circuit breaker	• If the breaker is tripped, reset it.
	Loose or corroded connections	• Clean and tighten loose battery and harness plug connection.
	Low battery output	• Check specific gravity of each battery. • Check electrolyte level of each battery.
	Defective electrical system ground wire:	• Repair or replace.
<b>Starter Cranks Slowly</b>	Low battery output	• Battery is too small. • Battery cables are too small.
	Check specific gravity of each battery	• Replace battery if necessary.
	Check electrolyte level of each battery	• If low, fill cells with distilled water.
	Crankcase oil too heavy	• Fill with oil of appropriate viscosity.
	Loose or corroded connections	• Clean and tighten loose connections.
<b>Entire Electrical System Does Not Function</b>	Check DC circuit breaker	• If breaker is tripped, reset it.
	Faulty connection	• Clean and tighten battery and harness plug connections.
	Sulfated or worn out batteries	• Check specific gravity and electrolyte level of each battery.

If you cannot correct problems with these procedures, see your **Northern Lights** dealer.

### ENGINE

PROBLEM	POSSIBLE CAUSE	RECOMMENDATION(S)
<b>Engine Hard to Start or Will Not Start</b>	Improper starting procedure	<ul style="list-style-type: none"> <li>• See starting section of this manual. Take special note of Bypass Switch operation.</li> </ul>
	No fuel	<ul style="list-style-type: none"> <li>• Check level of fuel in fuel tank.</li> </ul>
	Low battery output	<ul style="list-style-type: none"> <li>• Check electrolyte level and condition.</li> </ul>
	Excessive resistance in starting circuit	<ul style="list-style-type: none"> <li>• Clean and tighten all battery connections.</li> </ul>
	Crankcase oil too heavy	<ul style="list-style-type: none"> <li>• Use oil of proper viscosity.</li> </ul>
	Improper type of fuel	<ul style="list-style-type: none"> <li>• Consult fuel supplier and use proper type of fuel for operating condition.</li> </ul>
	Water, dirt or air in fuel system	<ul style="list-style-type: none"> <li>• Drain, flush, fill and bleed system.</li> </ul>
	Clogged primary fuel filter element	<ul style="list-style-type: none"> <li>• Clean or replace filter element.</li> </ul>
	Clogged secondary fuel filter element	<ul style="list-style-type: none"> <li>• Replace filter element.</li> </ul>
	Dirty or faulty injection nozzles	<ul style="list-style-type: none"> <li>• Have your dealer check injection nozzles.</li> </ul>
<b>Engine Runs Irregularly or Stalls Frequently</b>	Below normal engine temperature	<ul style="list-style-type: none"> <li>• Remove and check thermostat.</li> </ul>
	Clogged primary fuel filter element	<ul style="list-style-type: none"> <li>• Clean or replace filter element.</li> </ul>
	Clogged secondary fuel filter element	<ul style="list-style-type: none"> <li>• Replace secondary filter element.</li> </ul>
	Water or dirt in the fuel system	<ul style="list-style-type: none"> <li>• Drain, flush, fill and bleed system.</li> </ul>
	Dirty or faulty injection nozzles	<ul style="list-style-type: none"> <li>• Have your dealer check injection nozzles.</li> </ul>
	Air in fuel system	<ul style="list-style-type: none"> <li>• Inspect clamps and hoses on suction side of fuel pump for air leak.</li> </ul>
	Improper type of fuel	<ul style="list-style-type: none"> <li>• Consult fuel supplier and use proper type of fuel for operating condition.</li> </ul>
<b>Lack of Engine Power</b>	Intake air restriction	<ul style="list-style-type: none"> <li>• Service air cleaner.</li> </ul>
	Clogged primary fuel filter element	<ul style="list-style-type: none"> <li>• Clean or replace filter element.</li> </ul>
	Clogged secondary fuel filter element	<ul style="list-style-type: none"> <li>• Replace filter element.</li> </ul>
	Improper type of fuel	<ul style="list-style-type: none"> <li>• Consult fuel supplier and use proper type of fuel for operating conditions.</li> </ul>
	Overheated engine	<ul style="list-style-type: none"> <li>• See “Engine Overheats” in next category.</li> </ul>
	Below normal engine temperature	<ul style="list-style-type: none"> <li>• Remove and check thermostat.</li> </ul>
	Improper valve clearance	<ul style="list-style-type: none"> <li>• Reset valves. Best done by dealer.</li> </ul>
	Dirty or faulty injection nozzles	<ul style="list-style-type: none"> <li>• Replace injectors. Best done by dealer.</li> <li>• See your local dealer.</li> </ul>

## Troubleshooting

### ENGINE

PROBLEM	POSSIBLE CAUSE	RECOMMENDATION(S)
<b>Engine Overheats</b>	Low coolant level	<ul style="list-style-type: none"> <li>• Fill tank or radiator to proper level.</li> <li>• Check hoses for loose connections and leaks.</li> </ul>
	Keel cooling tubes have been painted (marine)	<ul style="list-style-type: none"> <li>• Remove paint from tubes.</li> </ul>
	Cooling system needs flushing	<ul style="list-style-type: none"> <li>• Flush cooling system.</li> </ul>
	Defective thermostat	<ul style="list-style-type: none"> <li>• Remove and check thermostat.</li> </ul>
	Defective temperature gauge	<ul style="list-style-type: none"> <li>• Check water temperature with thermometer and replace gauge if necessary.</li> </ul>
	Water pump impeller worn/broken	<ul style="list-style-type: none"> <li>• Check impeller and replace if necessary.</li> </ul>
<b>Engine Knocks</b>	Insufficient oil	<ul style="list-style-type: none"> <li>• Call your dealer.</li> </ul>
	Injection pump out of time	<ul style="list-style-type: none"> <li>• Call your dealer.</li> </ul>
	Below normal engine temperature	<ul style="list-style-type: none"> <li>• Check your thermostats.</li> <li>• Check water temperature to see if temperature gauge is working properly.</li> </ul>
	Engine overheating	<ul style="list-style-type: none"> <li>• See “Engine Overheating” section.</li> </ul>
<b>High Fuel Consumption</b>	Improper type of fuel	<ul style="list-style-type: none"> <li>• Use correct fuel for temperature.</li> </ul>
	Clogged or dirty air cleaner	<ul style="list-style-type: none"> <li>• Service air cleaner.</li> </ul>
	Improper valve clearance	<ul style="list-style-type: none"> <li>• See your dealer.</li> </ul>
	Injection nozzles dirty	<ul style="list-style-type: none"> <li>• See your dealer.</li> </ul>
	Injection pump out of time	<ul style="list-style-type: none"> <li>• See your dealer.</li> </ul>
	Engine not at proper temperature	<ul style="list-style-type: none"> <li>• Check your thermostats.</li> <li>• Check water temperature with thermometer and replace gauge if necessary.</li> </ul>
<b>Below Normal Engine Temperature</b>	Thermostat not working properly	<ul style="list-style-type: none"> <li>• Check thermostat.</li> </ul>
	Temperature gauge not working properly	<ul style="list-style-type: none"> <li>• Check water temperature with thermometer.</li> </ul>
<b>Low Oil Pressure</b>	Low oil level	<ul style="list-style-type: none"> <li>• Fill crankcase to proper level.</li> </ul>
	Improper type of oil	<ul style="list-style-type: none"> <li>• Drain and fill crankcase with correct oil.</li> </ul>
	Partially plugged oil filter	<ul style="list-style-type: none"> <li>• Replace filter.</li> </ul>
<b>High Oil Consumption</b>	Break-in period	<ul style="list-style-type: none"> <li>• Oil consumption decreases after break in.</li> </ul>
	Crankcase oil too light	<ul style="list-style-type: none"> <li>• Use proper viscosity oil.</li> </ul>
	Oil leaks	<ul style="list-style-type: none"> <li>• Check for leaks in lines around gaskets and drain plug.</li> </ul>

If you cannot correct problems with these procedures, see your **Northern Lights** dealer.



### ENGINE

PROBLEM	POSSIBLE CAUSE	RECOMMENDATION(S)
<b>Engine Emits Black or Gray Exhaust Smoke</b>	Clogged or dirty air cleaner	• Service air cleaner.
	Defective muffler (back pressure too high)	• Have dealer check back pressure.
	Improper fuel	• Use correct fuel for temperature.
	Injection nozzles dirty	• See your dealer.
	Engine out of time	• See your dealer.
<b>Engine Emits White Smoke</b>	Improper fuel	• Use correct fuel for temperature.
	Cold engine	• Warm up engine to normal operating temperature.
	Defective thermostat	• Remove and check thermostat.
	Engine out of time	• See your dealer.

If you cannot correct problems with these procedures, see your **Northern Lights** dealer.

## M843JK Data

Kilowatt Rating Prime Rated RPM/Frequency	10 kW 1800/60Hz	8 kW 1500/50Hz
<b>General Information</b>		
Cylinders	Inline 3	Inline 3
Displacement	81in <sup>3</sup> (1.33 liters)	81in <sup>3</sup> (1.33 liters)
Cycles	4	4
Bore x Stroke	3.3 x 3.2 in (84 x 80 mm)	3.3 x 3.2 in (84 x 80 mm)
Rotation (Facing Flywheel)	counter-clockwise	counter-clockwise
Compression Ratio	23:1	23:1
Total Engine Oil Capacity including Oil Filter	6.0 gal (5.7 liter)	6.0 gal (5.7 liter)
Aspiration	Natural	Natural
Flywheel Housing Size	SAE 4	SAE 4
Flywheel Drive Size	C-107	C-107
Rated Flywheel HP	17.5 HP	14.5 HP
Dry Weight w/Heat Exchanger (1 ∅)	662 lbs. (300 kg)	662 lbs. (300 kg)
Length	36.6 in (1078 mm)	36.6 in (1078 mm)
Width	19.3 in (490 mm)	19.3 in (490 mm)
Height	24.2 in (616 mm)	24.2 in (616 mm)
<b>Cooling System</b>		
Approx. Cooling Capacity HE	1.1 gal (4.1 liter)	1.1 gal (4.1 liter)
Minimum Through Hull Diameter	3/4 in (19 mm)	3/4 in (19 mm)
Sea Water Pump Inlet Hose ID	3/4 in (19 mm)	3/4 in (19 mm)
Minimum Sea Water Discharge	3/4 in (19 mm)	3/4 in (19 mm)
Heat Rejection to Jacket Coolant	703 BTU/min	548 BTU/min
Fresh Water Pump Capacity	13.3 gpm (50 lpm)	11.0 gpm (42 lpm)
Seawater Pump Cap.	9.0 gpm (34 lpm)	7.7 gpm (29 lpm)
Maximum Seawater Pump Suction Head	39 in (1M)	39 in (1M)
Keel Cooler TurboTube Length	4 feet (1.2 M)	4 feet (1.2 M)
Keel Cooler Head Diameter	1 in (25.4 mm)	1 in (25.4 mm)
Keel Cooler Water Hose ID	1.25 in (31.75 mm)	1.25 in (31.75 mm)
<b>D.C. Electrical</b>		
Minimum Battery Capacity	120 Amp/Hour	120 Amp/Hour
Battery Cable Size	#1	#1
Starting Voltage, Standard	12 Volt	12 Volt
<b>A.C. Electrical</b>		
Phase	1 Phase Std. (3 Phase Opt.)	1 Phase Std. (3 Phase Opt.)
<b>Air Intake and Exhaust</b>		
Air Consumption	35.2 cfm (1.0 M <sup>3</sup> /m)	29.3 cfm (.84 M <sup>3</sup> /m)
Maximum Exhaust Backpressure	48 in (1219 mm) H <sub>2</sub> O	48 in (1219 mm) H <sub>2</sub> O
Wet Exhaust Elbow OD	2 in (51 mm)	2 in (51 mm)
Exhaust Gas Volume	102 cfm (2.9 M <sup>3</sup> /m)	86 cfm (2.4 M <sup>3</sup> /m)
Exhaust Gas Temperature	1022° F (550° C)	1022° F (550° C)
<b>Fuel System</b>		
Minimum Suction Line	5/16-.3125 in (7.9 mm)	5/16-.3125 in (7.9 mm)
Minimum Return Line	5/16-.3125 in (7.9 mm)	5/16-.3125 in (7.9 mm)
Maximum Fuel Pump Suction Head	39 in (990 mm)	39 in (990 mm)
Specific Fuel Consumption at Max. Load	.446 lbs/hp/hr	.445 lbs/hp/hr
Approximate Fuel Rate at Max. Load	1.1 US gal/h	.91 US gal/h
<b>Maximum Engine Operating Angle</b>		
Continuous Operation	Front Down      Rear Down	Left/Right Down
(More than 2 minutes requires use of a remote expansion tank)	0°                      0° - 10°	0° - 23°
Intermittent Operation (Sustained up to two minutes)	0° - 35°              0° - 35°	0° - 35°

<b>Kilowatt Rating Prime Rated RPM/Frequency</b>	<b>12 kW 1800/60Hz</b>	<b>10 kW 1500/50Hz</b>
<b>General Information</b>		
Cylinders	Inline 3	Inline 3
Displacement	91 in <sup>3</sup> (1.5 L)	91 in <sup>3</sup> (1.5 L)
Cycles	4	4
Bore x Stroke	3.3 x 3.54 in (84 x 90 mm)	3.3 x 3.54 in (84 x 90 mm)
Rotation (Facing Flywheel)	counter-clockwise	counter-clockwise
Compression Ratio	22:1	22:1
Total Engine Oil Capacity including Oil Filter	5.8 gal (5.5 liter)	5.8 gal (5.5 liter)
Aspiration	Natural	Natural
Flywheel Housing Size	SAE 4	SAE 4
Flywheel Drive Size	C-107	C-107
Rated Flywheel HP	20.1 HP	16.6 HP
Dry Weight w/Heat Exchanger (1 ∅ )	700 lbs. (318 kg)	700 lbs. (318 kg)
Length	36.6 in (1078 mm)	36.6 in (1078 mm)
Width	19.3 in (490 mm)	19.3 in (490 mm)
Height	24.7 in (627 mm)	24.7 in (627 mm)
<b>Cooling System</b>		
Approx. Cooling Capacity	1.1 gal (4.1 liters)	1.1 gal (4.1 liters)
Minimum Through Hull Diameter	3/4 in (19 mm)	3/4 in (19 mm)
Sea Water Pump Inlet Hose ID	3/4 in (19 mm)	3/4 in (19 mm)
Minimum Sea Water Discharge	3/4 in (19 mm)	3/4 in (19 mm)
Heat Rejection to Jacket Coolant	790 BTU/min	658 BTU/min
Fresh Water Pump Capacity	13.3 gal/min (50 ltr/min)	11.0 gal/min (42 ltr/min)
Seawater Pump Cap.	9.0 gal/min (34 ltr/min)	7.7 gal/min (29 ltr/min)
Maximum Seawater Pump Suction Head	39 in (1M)	39 in (1M)
Keel Cooler Turbo Tube Length	4 feet (1.2 M)	4 feet (1.2 M)
Keel Cooler Head Diameter	1 in (25.4 mm)	1 in (25.4 mm)
Keel Cooler Water Hose ID	1.25 in (31.75 mm)	1.25 in (31.75 mm)
<b>D.C. Electrical</b>		
Minimum Battery Capacity	120 Amp Hour	120 Amp Hour
Battery Cable Size	#1	#1
Starting Voltage, Standard	12 Volt	12 Volt
<b>A.C. Electrical</b>		
Phase	1 Phase Std. (3 Phase Opt.)	1 Phase Std. (3 Phase Opt.)
<b>Air Intake and Exhaust</b>		
Air Consumption	39.6 cfm (1.13 M <sup>3</sup> /m)	33 cfm (.95 M <sup>3</sup> /m)
Maximum Exhaust Backpressure	48 in (1219 mm) H <sub>2</sub> O	48 in (1219 mm) H <sub>2</sub> O
Wet Exhaust Elbow OD	2 in (51 mm)	2 in (51 mm)
Exhaust Gas Volume	115 cfm (3.3 M <sup>3</sup> /m)	96 cfm (7.7 M <sup>3</sup> /m)
Exhaust Gas Temperature	1022° F (550° C)	1022° F (550° C)
<b>Fuel System</b>		
Minimum Suction Line	5/16-.3125 in (7.9 mm)	5/16-.3125 in (7.9 mm)
Minimum Return Line	5/16-.3125 in (7.9 mm)	5/16-.3125 in (7.9 mm)
Maximum Fuel Pump Suction Head	39 in (990 mm)	39 in (990 mm)
Specific Fuel Consumption at Max. Load	.423 lbs/hp/hr	.423 lbs/hp/hr
Approximate Fuel Rate at Max. Load	1.2 US gal/hr	.99 US gal/hr
<b>Maximum Engine Operating Angle</b>		
Continuous Operation	Front Down      Rear Down	Left Down      Right Down
(More than 2 minutes requires use of a remote expansion tank)	0°                      0° - 10°	0° - 23°              0° - 23°
Intermittent Operation (Sustained up to two minutes)	0° - 35°              0° - 35°	0° - 35°              0° - 35°

# Wiring Diagrams

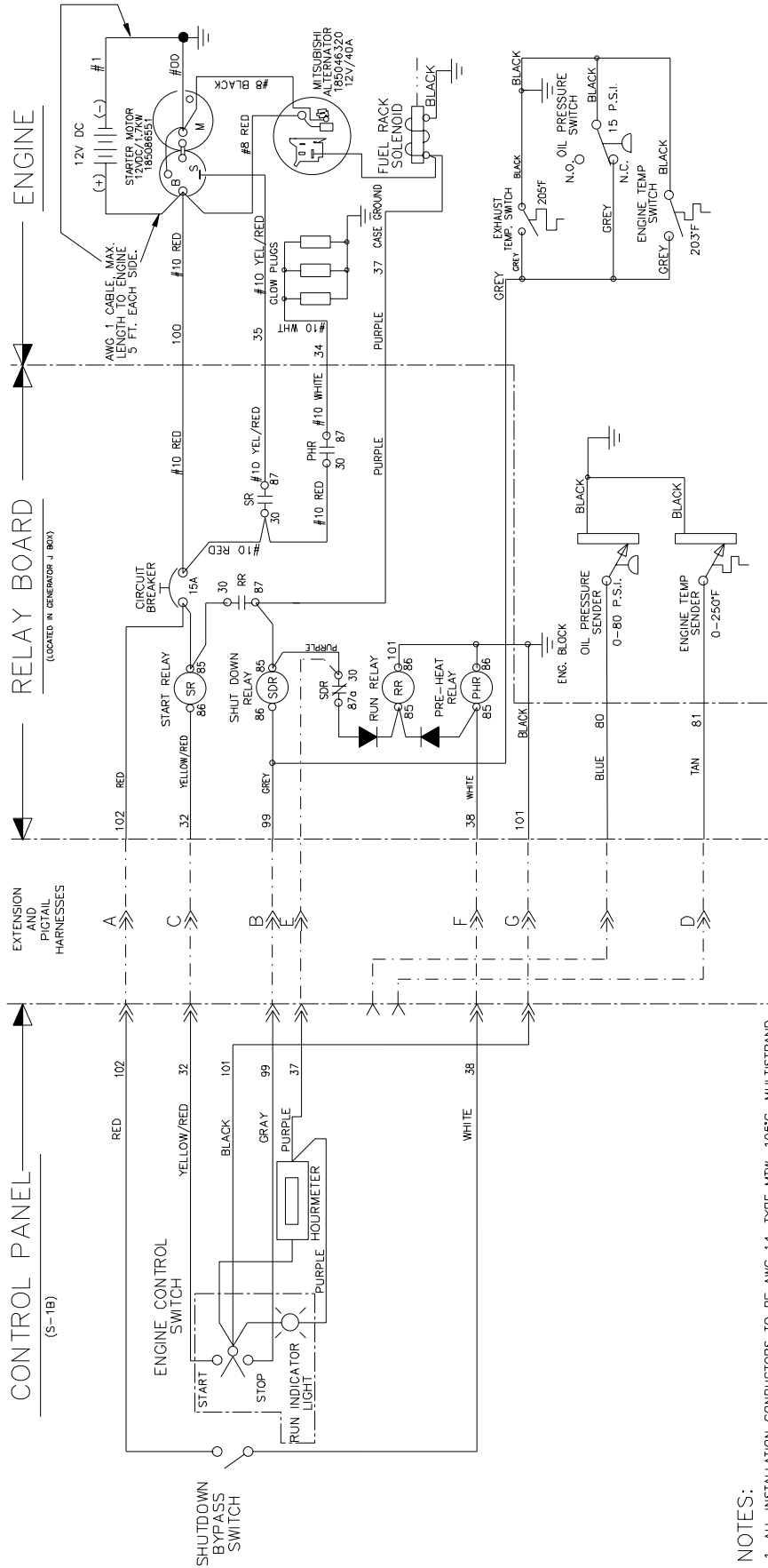

- NOTES:**
1. ALL INSTALLATION CONDUCTORS TO BE AWG 14, TYPE MTW, 105°C, MULTISTRAND, EXCEPT TWISTED SHIELDED PAIR AND AS NOTED.
  2. UNLESS COLOR CODED, ALL A.D.E. INSTALLED CONDUCTORS ARE TO BE GREY AND MUST BE IDENTIFIED BY NUMBER MARKER AT EACH CONNECTION POINT.

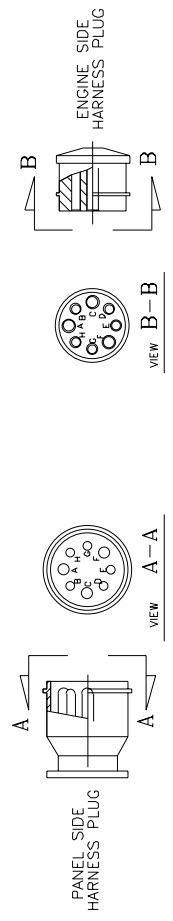

**Engine Wiring Schematic**  
M843 12V DC, Drawing B-7915

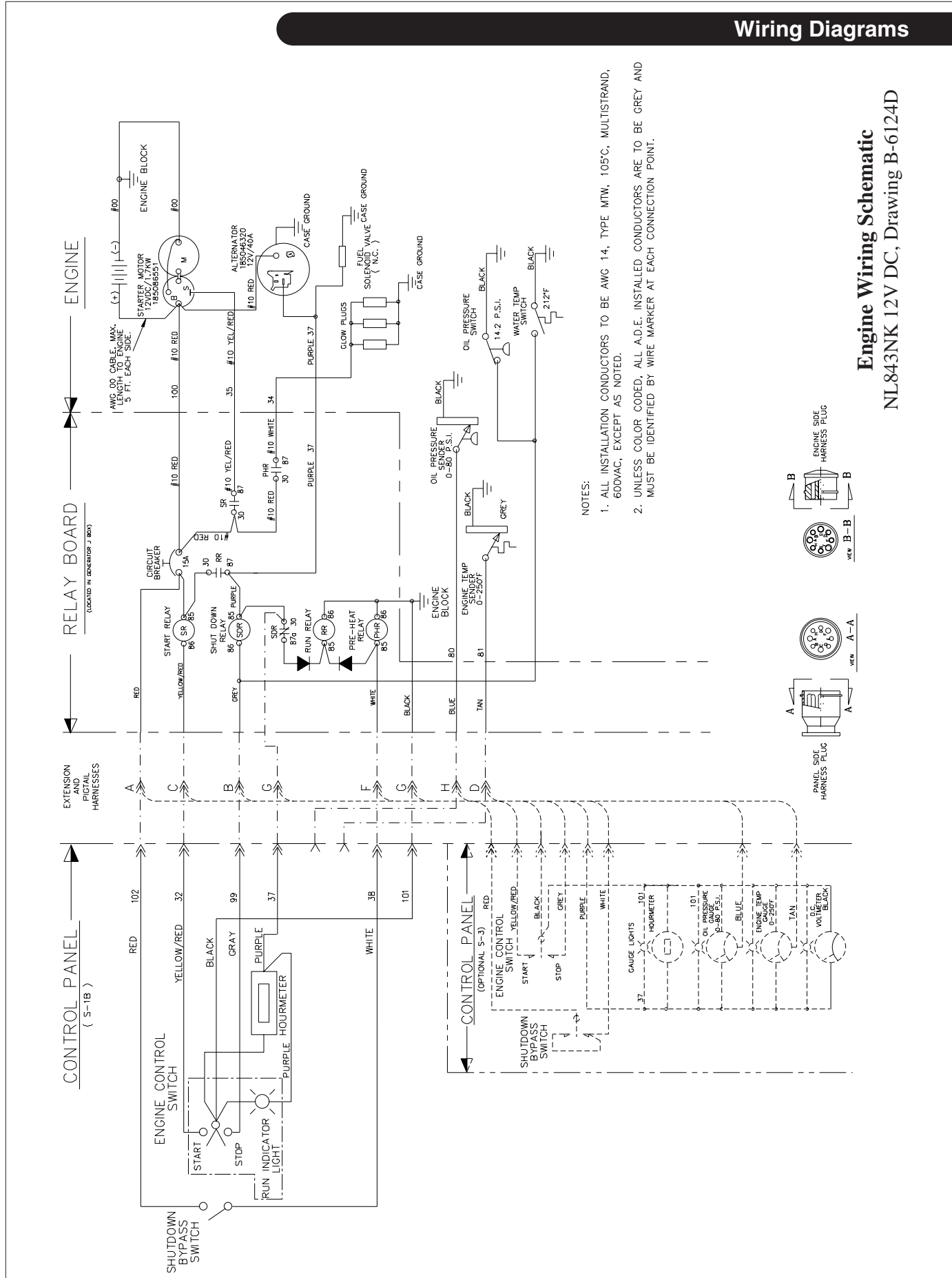

**Engine Wiring Schematic**  
NL843NK 12V DC, Drawing B-6124D

