

OM773LK
For Model: M773LK

OPERATOR'S MANUAL

Marine Generators | Marine Diesel Engines | Land-Based Generators



LUGGER





— CALIFORNIA —
Proposition 65 Warning:

Diesel engine exhaust and some of its constituents are known to the State of California to cause cancer, birth defects, and other reproductive harm.

Northern Lights

4420 14th Avenue N.W.

Seattle, WA 98107

Tel: (206) 789-3880

Fax: (206) 782-5455

Copyright ©2009 Northern Lights, Inc.
All rights reserved. Northern Lights™, and
the Northern Lights logo are trademarks of
Northern Lights, Inc.

Printed in U.S.A.
PART NO.: OM773LK 10/09



OPERATOR'S MANUAL

for Models

M773LK

Read this operator's manual thoroughly before starting to operate your equipment.

This manual contains information you will need to run and service your new unit.

Table of Contents

INTRODUCTION	2	SERVICING (CONTINUED)	
Models Included	2	Oil Changes	12
Model Numbers	2	Changing Oil Filter	12
Serial Numbers	2	Air Filter	13
WARRANTY	3	V-Belts	13
SAFETY RULES	3	Valve Clearances.....	13
COMPONENT LOCATIONS		Fuels - General.....	14
M773LK Marine Generator.....	4	Fuel Filters	14
PANELS		Bleeding the Fuel System	15
Northern Lights Generator Sets	5 - 6	Injector Service.....	16 - 17
OPERATING PROCEDURES		Injection Pump.....	17
Break-in Period.....	8	Cooling System - General.....	17
Before Starting.....	8	Cooling System Flushing.....	18
Starting.....	8	Heat Exchanger.....	18
Operating	8	Raw Water Pump	18
Stopping.....	8	Generator Ends	18
Shutdowns and Alarms	9	Electrical System - General	18
Spare Parts	9	Glow Plugs.....	19
SERVICING SCHEDULE CHART	10	Booster Batteries.....	19
SERVICING		Battery Care.....	19
Lubrication - General.....	12	Winterizing / Out-of-Service	19
Checking Oil.....	12	TROUBLESHOOTING	
		Electrical	20
		Engine	21 - 23
		WIRING DIAGRAMS	
		DC Electrical	24

Proprietary Information

This publication is the property of Northern Lights, Inc.

It may not be reproduced in whole or in part without the written permission of Northern Lights, Inc.

© Northern Lights, Inc. All rights reserved. Litho U.S.A. Publication number OM773LK 10/09

Introduction

Servicing of marine engines and generator sets presents unique problems. In many cases boats cannot be moved to a repair facility. Marine engines cannot be compared to the servicing of automobiles, trucks or even farm equipment. Failures often occur in remote areas far from competent assistance. Marine engines are taxed far more severely than auto or truck engines; therefore, maintenance schedules must be adhered to more strictly.

Failures begin with minor problems that are overlooked and become amplified when not corrected during routine maintenance.

As operator, it is your obligation to learn about your equipment and its proper maintenance. This is not a comprehensive technical service manual. Nor will it make the reader into an expert mechanic. Its aim is to aid you in maintaining your unit properly.

Unit Identification

MODELS INCLUDED

This manual covers the operating instructions for:

M773LK marine generator sets

Model Numbers

Model numbers give the unit's application, block model, aspiration, and RPM:

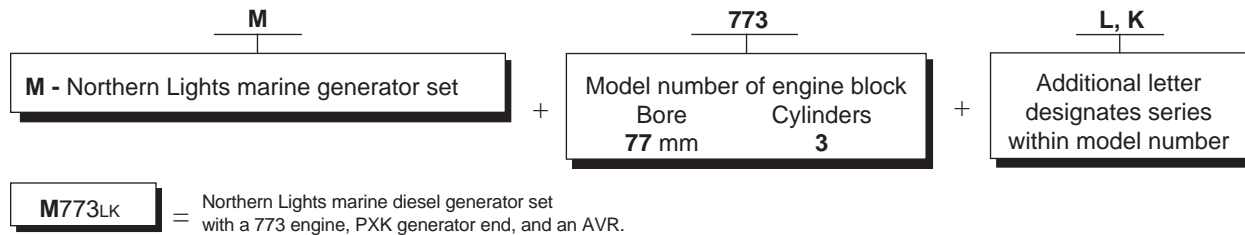

Serial Numbers

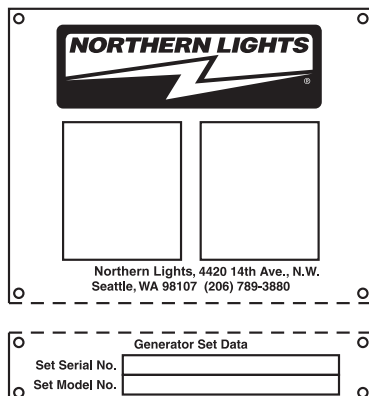

Your set has three serial numbers: ① an engine number stamped on the block, ② a generator plate, and ③ a generator set plate.

Use the serial number on the generator set plate when ordering parts or in correspondence. The generator set plate is found on the service side of the generator and resembles the drawing in Figure 1.

Figure 1: Generator set serial number plate.

A warranty registration certificate is supplied with your set. It entitles the original purchaser of our equipment to a warranty covering material or assembly faults. The extent of coverage is described in the Limited Warranty Statement. We recommend that you study the statement carefully.

NOTE: If the warranty is to apply, the servicing instructions outlined in this manual must be followed. If further information is needed, please contact an authorized dealer or the factory.

Safety Rules



CAUTION: *Accident reports show that careless use of engines causes a high percentage of accidents. You can avoid accidents by observing these safety rules. Study these rules carefully and enforce them on the job.*

- Never leave engine without proper security.
- Turn the coolant tank cap slowly to relieve pressure before removing. Add coolant only when the engine is stopped and cool.
- Mount a fire extinguisher near engine.
- Always disconnect the battery ground strap before making adjustments.
- Operate engines in properly ventilated areas.
- Keep trash and other objects away from engine.
- Escaping fluids under pressure can penetrate your skin. Use a piece of cardboard or wood, not your hands, to search for leaks.
- Avoid wearing loose clothing without a belt when working around engines.
- Do not oil or grease engine while it is running.
- Use caution in handling fuel. Never refuel a hot or running engine. Do not smoke while filling fuel tank or servicing fuel system.
- Keep your hands, feet, hair and clothing away from power-driven parts.
- Check for any loose electrical connections or faulty wiring.
- Engines should be operated only by knowledgeable, qualified personnel.
- Look completely around engine to make sure that everything is clear before starting.
- Do not operate an engine that isn't in proper working order. If an unsafe operating condition is noted, tag the set and control panel so others will also know about the problem.
- Provide first aid kits.



CAUTION: *This symbol is used throughout this book to alert you to possible danger areas. Please take special notice of these sections.*

Marine Generator Component Locations

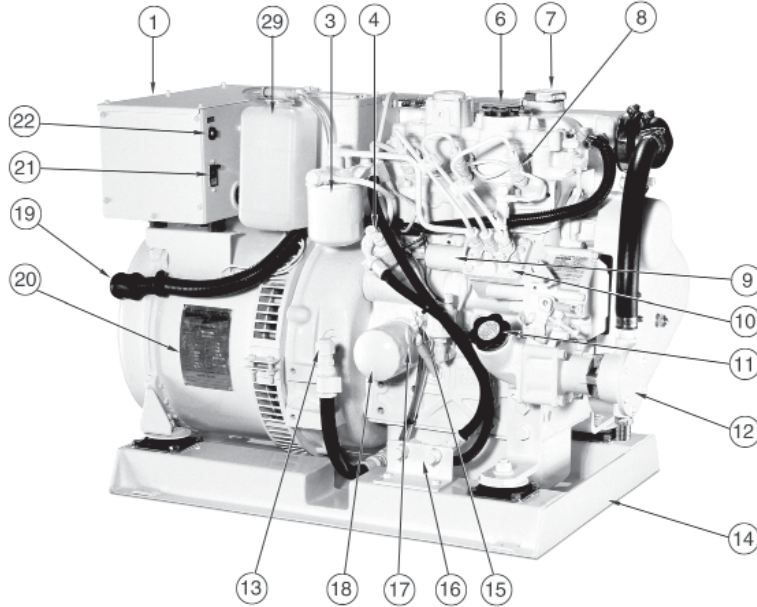

Figure 2: M773LK Service Side with PX-309K generator end.

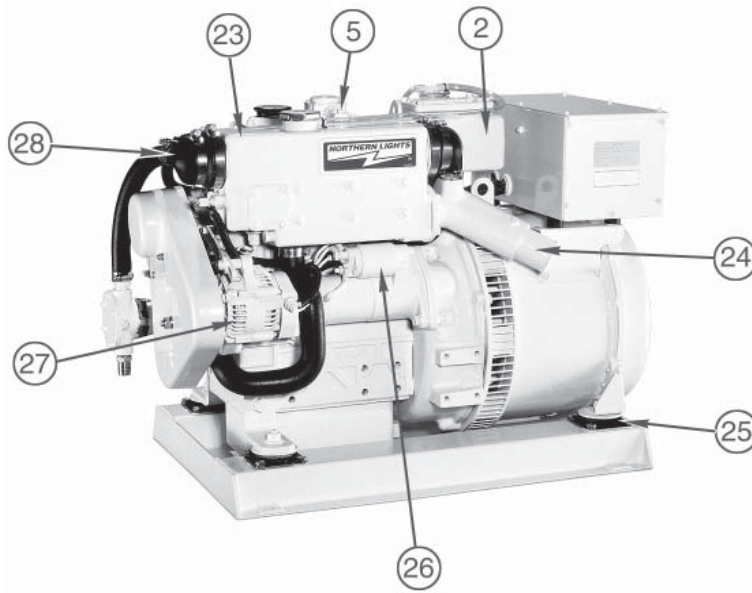

Figure 3: M773LK Non-Service Side with PX-309K generator end.

- | | | | |
|--------------------------|------------------------|--------------------------------|-----------------------------|
| 1. Generator Control Box | 8. Fuel Injector | 15. Block Drain | 22. DC Circuit Breaker |
| 2. Air Filter | 9. Stop Solenoid | 16. Fuel Inlet and Return | 23. Expansion Tank |
| 3. Fuel Filter | 10. Injection Pump | 17. Lube Oil Dipstick | 24. Wet Exhaust Elbow |
| 4. Fuel Lift Pump | 11. Lube Oil Fill Side | 18. Lube Oil Filter | 25. Vibration Mount |
| 5. Crankcase Vent | 12. Seawater Pump | 19. Control Panel Plug-In | 26. Starter |
| 6. Lube Oil Fill Top | 13. Lube Oil Drain | 20. Generator Set Plate | 27. DC Alternator |
| 7. Coolant Fill | 14. Base Frame | 21. AC Circuit Breaker for AVR | 28. Heat Exchanger End Cap |
| | | | 29. Coolant Recovery Bottle |

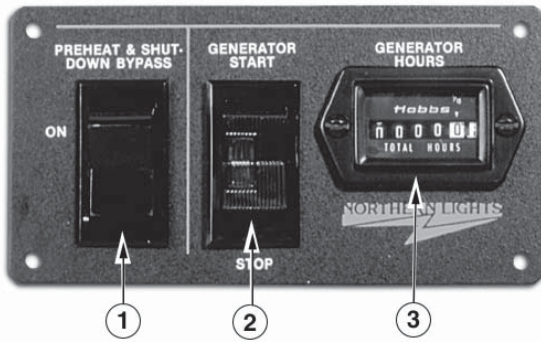

Figure 6-A: Series 1-B Generator Control Panel



Figure 6-B: Series 3 Generator Control Panel

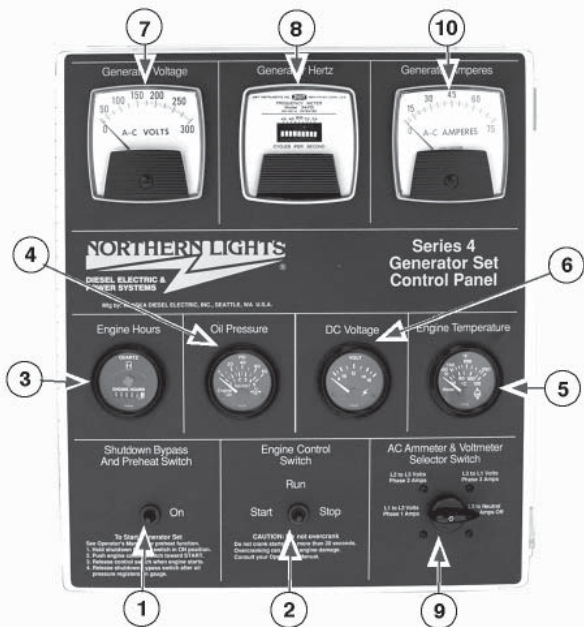

Figure 6-C: Series 4 Generator Control Panel

1. SHUTDOWN BYPASS-PREHEAT SWITCH

There are two functions built into this switch: preheating the engine and bypassing the engine safety shutdown circuit, enabling a quicker start. Hold the switch in the ON position for approximately 10 to 20 seconds before starting a cold engine. Holding the switch ON for too long can burn out the glow plugs. *NOTE: Three position Engine Control switches must be in the RUN position during preheating. Preheat switch must be held in ON position during starting.*

2. ENGINE CONTROL SWITCH

To start the engine, hold this switch in the START position until the engine is running. *NOTE: Excessive cranking of marine sets equipped with water lift muffler systems can cause engine damage. See page 8.* After the engine starts, release the switch and it will return to RUN position. To stop the engine, hold the switch in the STOP position. *NOTE: The rocker switch is used on Series 1 panels only, and has a light that glows when the set is running.*

3. HOUR METER

Keeps track of engine running time.

4. OIL PRESSURE GAUGE

Shows the oil pressure in the engine lubricating system.

5. WATER TEMPERATURE GAUGE

Registers the temperature of the cooling water.

6. D.C. VOLTMETER OR AMMETER

When the engine is stopped, the voltmeter indicates the condition of the battery. When the engine is running, the voltmeter indicates the voltage output of the alternator.

For Series 4 Control Panels Only:

7. A.C. VOLTMETER

Shows the generator output voltage.

8. FREQUENCY METER (Hertz)

The frequency meter indicates engine speed: 1200 or 1800 RPM (60 Hz), or 1500 RPM (50 Hz).

9. AMMETER SELECTOR SWITCH

Used to check each phase for load condition. *NOTE: Always leave this switch in the ON position while the unit is running.*

10. A.C. AMMETER

Shows the generator load on each phase. The phase is selected with the Ammeter Selector switch (Item 9).

Control Panels

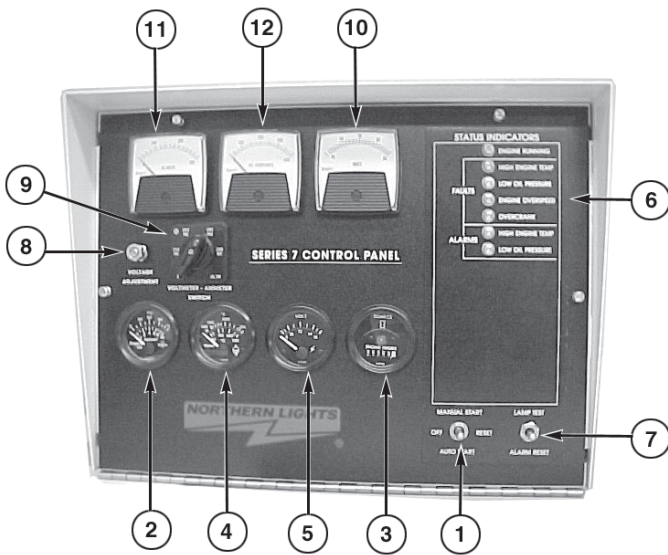

Figure 7-A: Series 7.0 through Series 7.6 Generator Control Panels.

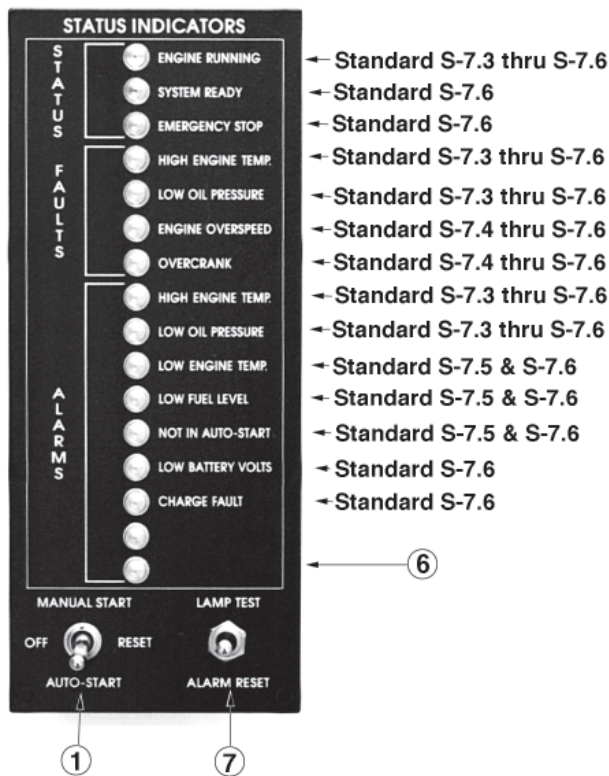

Figure 7-B: Status Indicators for Series 7.0 through Series 7.6 Generator Control Panels.

1. SHUTDOWN BYPASS SWITCH

Manual Start Panels
(S-7.1 and S-7.3)

Hold the switch in the START position until the engine is running.

NOTE: Excessive cranking may cause engine damage.

After the engine starts, release the switch and it will return to the RUN position. To stop the engine, hold the switch in the STOP position.

Auto Start Panels
(S-7.0, S-7.2, S-7.4, S-7.5, and S-7.6)

When the switch is placed in the AUTO START position, the unit will automatically start when there is a drop in utility power.

2. OIL PRESSURE GAUGE

Shows the oil pressure in the engine lubricating system.

3. HOUR METER

Keeps track of engine running time.

4. ENGINE TEMPERATURE GAUGE

Registers the temperature of the coolant.

5. D.C. VOLTMETER

When the engine is running, the voltmeter indicates the voltage output of the alternator.

6. STATUS INDICATOR PANEL

Engine monitoring alarms and lamps for monitoring engine functions.

7. ALARM LAMP TEST AND RESET BUTTON

Press UP to test the indicator lights and press DOWN to reset the alarm.

8. A.C. VOLTAGE ADJUSTMENT RHEOSTAT

Voltage has been set at the factory and should only be adjusted by factory-trained personnel.

9. AMMETER SELECTOR SWITCH

Used to check each phase for load condition.

NOTE: Always leave this switch in the ON position while the unit is running.

10. FREQUENCY METER (HERTZ)

The frequency meter indicates alternator current frequency: 60 Hz (1200 or 1800 RPM), or 50 Hz (1500 RPM).

11. A.C. VOLTMETER

Shows the generator output voltage.

12. A.C. AMMETER

Shows the generator load on each phase. The phase is selected with the Ammeter Selector switch.

Operating Procedures

BREAK-IN PERIOD

1. The first 100 hours on a new or reconditioned engine are critical to its life and performance.
2. Constantly check the engine temperature and oil pressure gauges (sets with Series 3 or 4 panels).
3. Oil consumption is greater during break-in as piston rings take time to seat.
4. Break-In Oil Changes: Change engine oil and filter at 50 hours. Change oil and filter again at 100 hours (consult Lubricants section for oil recommendation), then at every 250 hours.

Operating Instructions:

Maintain at least a 75% load on your generator set for the first 100 hours. If this is not possible, maintain no less than a 50% load to ensure proper seating of the piston rings. Vary the load to help seat the rings.

BEFORE STARTING

1. Check the water level by removing the pressure cap from the expansion tank. The level should be at the filler cap sealing surface when the engine is cold.



CAUTION: Use protective clothing and open the filler cap carefully when the engine is warm to prevent burns.

2. Check the oil level in the crankcase with the dipstick. The oil level must be in the waffled area on the stick. Never allow the level to go below this area. Always add the same viscosity of oil as is already in the crankcase.
3. Check the fuel tank level and open any fuel valves.
4. Close the sea-cock, check and clean the sea strainer and reopen the sea-cock.
5. Place the battery switch in the ON position.
6. **NOTE:** The battery switch must always be kept ON while the engine is running. If the switch is turned OFF while the engine is running, the battery charging regulator could be ruined.

STARTING

1. Hold the Shutdown Bypass-Preheat switch in the ON position for 10 to 20 seconds before starting a cold engine. Holding the switch too long can burn out the glow plugs. This step is not necessary if the engine is already warm.
2. While holding the Shutdown Bypass-Preheat switch in the ON position, push the Engine Control switch to the START position.
3. As soon as the engine starts, release both switches. Do not crank the starter for more than 20 seconds consecutively. If the engine fails to start with the first attempt, be sure that it has stopped completely before re-engaging.
6. **NOTE:** Excessive cranking of the starter on sets equipped with a water lift muffler can cause engine damage. If the engine does not start after three 20-second cranks, remove the impeller from the raw water pump. This will prevent the muffler from filling with water and backfilling the exhaust line and engine. Once the engine starts, shut it off immediately and re-install the impeller. Re-start the engine and check the exhaust overboard outlet for gushes of water.

OPERATING

1. Units with Series 3 and Series 4 Control Panels: check gauges often. Oil pressure must be above 15 PSI. The D.C. voltmeter should read between 11 and 15 volts at 80°F (25°C) ambient temperature. The water temperature gauge must be below 200°F (94°C). Check the A.C. voltage and frequency meters (Series 4 panel). If the gauges deviate from normal levels, shut down the generator set and investigate.
2. Let the unit run unloaded for a three to five minute warm-up period.
3. Add electrical load.

STOPPING

1. Remove electrical load from the generator set.
2. Move the Engine Control switch to the STOP position momentarily.
3. Shut off the seacock, fuel valve, and battery switch.

SHUTDOWNS AND ALARMS

1. Generator sets have shutdown systems to stop the engine in the event of high water temperature or low oil pressure.
 - a. Other alarms and shutdowns are available as optional equipment.

NOTE: Do not rely on your shutdown to the exclusion of careful gauge monitoring. Watching your gauges can prevent damage to the unit and dangerous power losses.

2. Do the following when your warning or shutdown system is activated:
 - a. Check the temperature gauge.
If above 205°F (96°C), shut off the engine immediately.
 - b. Use the Trouble Shooting Guide on page 20 to isolate the cause of the overheat.



CAUTION: Do not remove the water fill cap of an overheated engine. Escaping high temperature steam can cause severe burns. Allow the engine to cool and then remove the cap slowly using protective clothing.

- c. Make repairs. Restart your set after the temperature gauge registers below 200°F (94°C).
 - d. Watch the temperature gauge regularly and turn off the unit if the temperature rises above 205°F (96°C) on Marine units. Repeat trouble shooting.
3. If shutdown is activated and the temperature gauge shows temperature within normal temperature range:
 - a. Check the engine crankcase oil level.
 - b. If the oil level is low, fill with recommended lubricating oil and restart. Watch the oil pressure gauge carefully and shut off the engine if it does not show a normal reading (20-60 PSI) after a few seconds of operation.
 - c. If the oil level is normal, DO NOT restart the engine. Call your dealer for assistance.

SPARE PARTS

1. Northern Lights recommends that you keep the following spare parts on hand for field service. The parts are available from your local Northern Lights dealer.
Marine models have optional “On-Board-Kits,” a handy box that contains the most common parts you will need.
2. All owners should have the following:
 - a. Primary and secondary fuel filter elements
 - b. Oil filters
 - c. Alternator belt
 - d. Thermostat and gaskets
 - e. Seawater pump impeller & gaskets
 - f. Glow plug
 - g. Injector and washer
3. If your set is operating a long distance from a servicing dealer, add the following:
 - a. Complete set of injectors
 - b. Copper washers for injector change
 - c. Complete set of glow plugs
 - d. Fuel lift pump

Servicing Schedule Chart

The Servicing Schedule Chart below shows the service schedule required for proper maintenance of your generator set. More detailed coverage of each Service Point (SP) is listed on the page noted in the 'page' column.

DAILY:

- SP1 Check oil level in engine
- SP5 Check V-belt tension
- SP7 Check primary fuel filter
- SP13 Check coolant level
Check sea strainer
- SP18 Check electrolyte in batteries

AFTER FIRST 50 HOURS:

- SP2/3 Change engine oil and filter
- SP6 Adjust valves

AFTER FIRST 100 HOURS:

- SP2/3 Change engine oil and filter

EVERY 250 HOURS:

- SP2/3 Change engine oil and filter
- SP4 Check air cleaner
- SP19 Check state of charge of batteries

EVERY 500 HOURS:

- SP8 Change primary fuel filter element
- SP9 Change secondary fuel filter
- SP16 Check condition of exhaust elbow

EVERY 1000 HOURS:

- SP4 Change air cleaner element
- SP6 Check valve clearances
- SP11 Check injectors
- SP17 Change impeller

EVERY 2500 HOURS:

- SP12 Check fuel injection pump
- SP14 Check and flush cooling system
- SP15 Check and clean heat exchanger

SERVICE POINT	PAGE	OPERATION	DAILY	50 Hours	250 Hours	500 Hours	1000 Hours	2500 Hours
ENGINE:								
SP1	8 & 12	Check oil level	•					
SP2	12	Change engine oil		•	•			
SP3	12	Change lube oil filters		•	•			
SP4	13	Check air cleaner			•			
SP5	13	Check V-belt tension	•					
SP6	13	Check valve clearances					•	
FUEL SYSTEM:								
SP7	14	Check primary filter (Racor)	•					
SP8	14	Change primary filter element (Racor)				•		
SP9	14	Change secondary fuel filter				•		
SP10	15	Bleed the fuel system						
SP11	17	Check injectors					•	
SP12	17	Check fuel injection pump						•
COOLING SYSTEM:								
SP13	8 & 17	Check coolant level	•					
SP14	18	Check and flush cooling system						•
SP15	18	Check and clean heat exchanger						•
SP16		Check condition of exhaust elbow				•		
SP17	18	Change impeller in raw water pump					•	
ELECTRICAL SYSTEM:								
SP18	19	Check electrolyte level in batteries	•					
SP19	19	Check condition of batteries with hydrometer			•			
OUT OF SERVICE:								
SP20	19	Winterizing or out-of-service						

- 1) Perform all maintenance once a year even if hour level has not been reached.
- 2) Consult manufacturer's maintenance schedule, note on chart.
- 3) Whenever necessary.

- 4) More often if necessary.
- 5) After first 50 hours, then after first 100 hours, then every 250 hours.
- 6) Change air cleaner element at 1000 hours.

Servicing

LUBRICATION - GENERAL

1. Use only clean, high quality lubricants stored in clean containers in a protected area.
2. These lubricants are acceptable:
 - a. API Service CC/CD/CE single viscosity oils.
 - b. API Service CC/CD/SF multi-viscosity oils.
3. Use the proper weight oil for your average operation temperature.

Air Temperature	Single Viscosity	Multi-Viscosity
Above 32°F (0°C)	SAE 30W	SAE 15-40W
-10 to 32°F (-23 to 0°C)	SAE 10W	SAE 10-30W
Below -10°F (-23°C)	SAE 5W	SAE 5-20W

Figure 8: Lube Oils

4. Some increase in oil consumption may be expected when SAE 5W and SAE 5-20W oils are used. Check oil level frequently.
5. Never put additives or flushing oil in crankcase.

SP1. CHECKING OIL LEVEL

1. Check the oil level in the crankcase with the dipstick. The oil level must be in the waffled area on the stick. Never allow the level to go below this area. Follow the lubrication recommendations above.

SP2. OIL CHANGES

1. The set is delivered with special break-in oil. Change the engine oil and oil filter after 50 hours of operation. Use Service CC 30 weight oil during the first 100 hours.
2. Change the oil and filter again at 100 hours using the oil recommended in Figure 8. After this, change oil and filter every 250 hours.
3. During intermittent cold weather operation, change oil every 100 hours or six weeks, whichever comes first.
4. Change oil at any seasonal change in temperature when a new viscosity of oil is required.
5. Change oil when engine is warm.
6. Dispose of waste oil in an approved manner.
7. Never use a flushing oil.
8. Remove cap on oil drain tube. Drain oil. Replace the cap and tube.
9. Refill engine with recommended oil.
10. Engine capacity with new oil filter is:
773LK – 4.2 quarts (4 liters)

SP3. CHANGING LUBE OIL FILTER

1. Change the lube oil filter every 250 hours.
2. Use a filter wrench to remove old filter. Dispose of filter in approved manner.
3. Make sure the gasket from the old filter is removed and discarded. Clean mount face.
4. Spread a thin film of engine oil on the rubber gasket on the new filter and screw it on nipple until gasket meets the sealing surface.
5. Using hands only – no wrench – tighten filter one-half turn farther. Overtightening can do damage to filter housing.
6. Fill engine with recommended oil. Start engine and check for leakage. Stop engine, wait 3 minutes, and check oil level. Add additional oil if necessary.
7. Oil filter part numbers are:
773LK – #24-02001

SP4. AIR CLEANER

1. Inspect air cleaner every 250 hours. In dusty conditions, check more often.
2. Generator sets: if dirty, wash element in soapy water. Rinse and dry thoroughly before re-installing. Replace if necessary. Part numbers are:

M773LK – #24-28602

3. **NOTE: Make absolutely sure no impurities enter the engine while changing the element. Do NOT run the engine with the air cleaner removed.**

SP5. V-BELTS

1. Check the tension and wear on the V-belt daily.
2. Use your thumb to press on the belt at the midpoint between the crankshaft and alternator pulleys. The tension is correct if the belt can be depressed about 3/16 in. (5 mm).

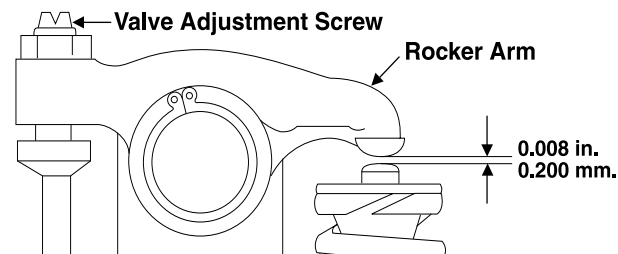

Figure 10: Valve Adjustment

SP6. VALVE CLEARANCES

1. Adjust valve clearance after first 50 hours of operation and every 1000 hours thereafter.
2. The engine should be cold and NOT running.
3. Watch the valves while turning the engine over by hand. Turn until the inlet valve starts to open and the exhaust valve starts to close (the valves are rocking). Then turn the crankshaft one more full turn and adjust the clearance on both valves for this cylinder.
4. Loosen the lock nut and adjust the clearance between the rocker arm and valve guide of both the intake and exhaust valves with the adjustment screw (Figure 10). Clearance on both intake and exhaust valves should be 0.008 in. (0.2 mm).
5. Repeat steps 3 and 4 for each cylinder. Each set of valves must be adjusted individually.
6. Replace the rocker arm cover. Tighten cover nuts to 5 - 8 ft/lbs (0.8 - 2.3 kg/m).

FUELS - GENERAL

1. Use only clean, high quality fuels of the following specifications, as defined by ASTM designation D975 for diesel fuels:
 - a. Use grade no. 2 diesel at ambient temperatures above freezing 32°F (0°C).
 - b. Use grade no. 1 at ambient temperatures below freezing and for all temperatures at an altitude of above 5,500 ft. (1500 meters).
2. Use fuel having less than 1% sulphur (preferably less than 0.5%).
3. The cetane number should be a minimum of 45.
4. DO NOT use these unsuitable grades of fuel:
 - a. Domestic heating oils, all types.
 - b. Class B engine.
 - c. Class D domestic fuels.
 - d. Class E, F, G or H industrial or marine fuels.
 - e. ASTM-D975-60T No. 4-D and higher number fuels.
5. Storing fuel:
 - a. Keep dirt, scale, water, and other foreign matter out of fuel.
 - b. Avoid storing fuel for long periods of time.
 - c. Fill the fuel tank at the end of each day's operation. This will reduce condensation.

SP7-9. FUEL FILTERS

1. Your generator set should have a primary fuel filter installed. We recommend the Racor brand of fuel filter-water separators.
 - a. Check the primary fuel filter daily as recommended by the filter manufacturer. Empty the collection bowl as necessary.
 - b. Change the element as often as necessary or every 500 hours.
 - c. If the bowl fills with water, change the primary and secondary element immediately.
2. Change secondary fuel filter every 500 hours.
 - a. Remove the spin-on filter by turning it counterclockwise with a filter wrench. Fill the new cartridge with fuel and install it after applying engine oil to gasket surface. Screw on until the gasket surface comes into contact with sealing surface of filter base. Then, tighten it two-thirds of a turn by hand. Do not overtighten.
 - b. Fuel filter part numbers are:
773LK – #24-52020

SP10. BLEEDING THE FUEL SYSTEM



CAUTION: Escaping diesel fuel under pressure can penetrate skin causing serious personal injury. Before disconnecting lines be sure to relieve all pressure. Before applying pressure, be sure all connections are tight and lines, pipes and hoses aren't damaged. Fuel escaping from a very small hole can be almost invisible. Use a piece of cardboard or wood, rather than hands, to search for suspected leaks. If injured by escaping fuel, see a doctor at once. Serious infection or reaction can develop if proper medical treatment isn't administered immediately.

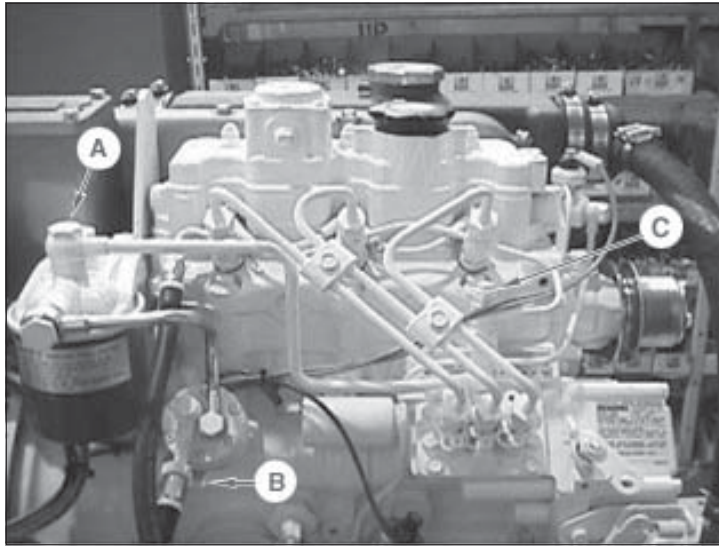

Figure 11: M773LK Fuel System.

1. The fuel system is self-bleeding. However, any system may need manual bleeding when:
 - a. A new fuel filter is installed;
 - b. The engine has run out of fuel;
 - c. The fuel lines, injection pump or any other fuel system component has been removed and installed.
2. Loosen bleed bolt "A" (Figure 11) on top of the filter. Pump hand primer "B" on fuel lift pump until pure fuel (no bubbles) escapes from bleed bolt "A". Tighten bleed screw "A".
3. Loosen bleed screw "C". Pump hand primer "B" until pure fuel (no bubbles) escapes. Then tighten bleed screw "C".
4. If the engine does not start after the above bleeding process, loosen a fuel line at the injector while cranking the engine with the starter motor until pure fuel escapes. Then tighten the connection. Do each line **one-at-a-time**.
5. After the engine has started, use a piece of cardboard to look for fuel leaks.

Servicing

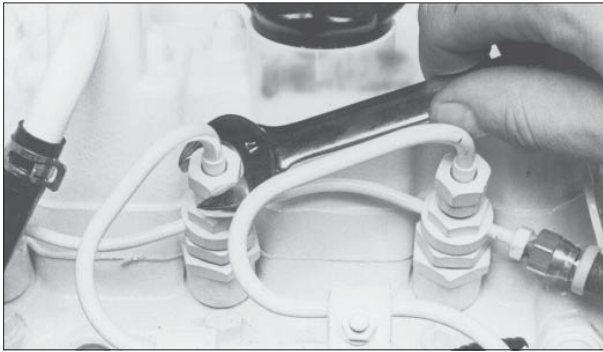

Figure 12: Remove delivery line flare nuts.

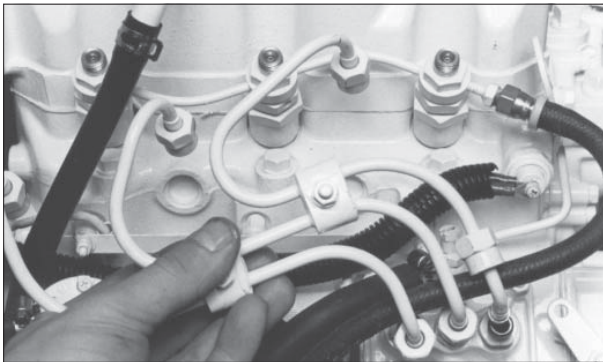

Figure 13: Remove delivery lines.

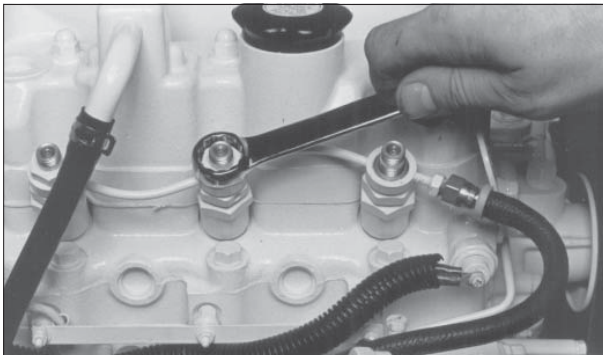

Figure 14: Remove return line nuts.

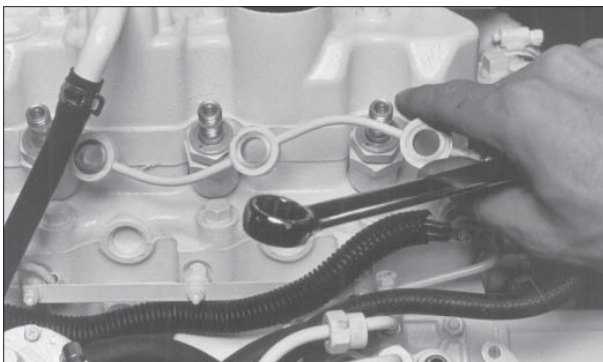

Figure 15: Remove return line.

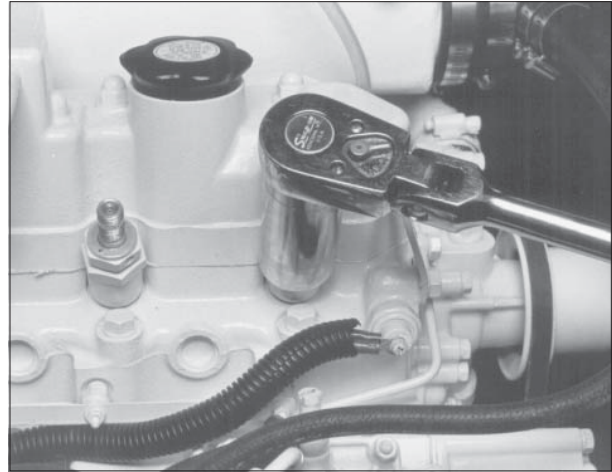

Figure 16: Unscrew injector.

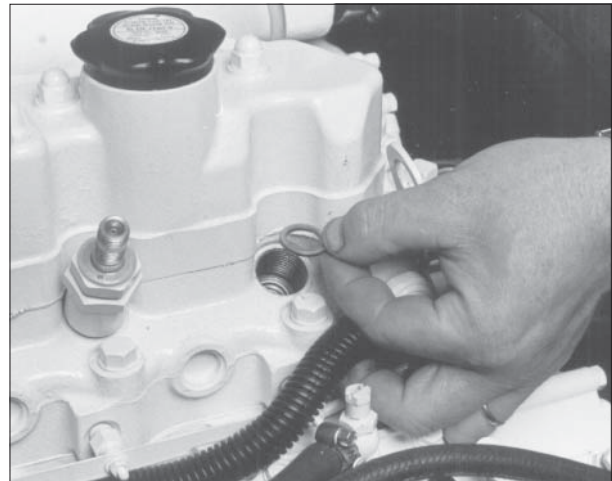

Figure 17: Remove and replace copper sealing washer.



Figure 18: Reinstall injector. Torque to proper tightness.

SP11. INJECTOR SERVICE

1. Injectors should be checked every 1000 hours. Check should be made by a Northern Lights dealer or local injection repair station.



CAUTION: *Escaping diesel fuel under pressure can have sufficient force to penetrate the skin causing serious personal injury. If injured by escaping diesel fuel, see a doctor at once.*

2. Injector removal:

- a. Clean loose dirt from around the injectors and the fuel lines.
- b. Relieve high pressure in the fuel lines by loosening the delivery line flare nuts at each injector (Figure 12).
- c. Remove delivery lines by disconnecting from injectors and injection pump (Figure 13). Remove all lines as an assembly; do not remove the clamps. Cover the ends of the lines, the injector inlets and injection pump outlets to keep dirt out.
- d. Remove the return line retaining bolts (Figure 14). Remove the return line (Figure 15).
- e. Unscrew and remove the injectors (Figure 16).
NOTE: *Do not use pry bars to remove injectors from cylinder head.*
- f. After removing the injectors, discard the copper sealing washers from the injector hole in the head (Figure 17). Cover holes to prevent dirt and debris from entering the cylinders.

3. Injector installation:

- a. Install a new copper sealing washer in each injector hole (Figure 17).
- b. Screw in injector and tighten to 43 or 50 ft/lbs (6 to 7 kgm) (Figure 18).
NOTE: *Overtightening can damage injector.*
- c. Install return line using new sealing washer below each connection. Tighten return line retaining bolts to 22 - 30 ft/lbs.
- d. Install delivery lines. Leave loose at injectors for bleeding.
- e. Pump hand lever on fuel pump to fill lines. Tighten lines at injectors. Start engine and check for leaks using a piece of paper or cardboard.

DO NOT use hand to check for leaks.

SP12. INJECTION PUMP

1. Since operating conditions may vary considerably, it is difficult to give a definite interval for checking the injection pump. But as a rule, pump settings, maximum speed, idle speed and exhaust smoke should be checked after every 2500 hours of operation. Service of the fuel injection pump should only be done if checks indicate pump malfunction.
2. Black smoke can be an indication of pump malfunction. Before servicing the pump, check other possible causes:
 - a. Check cleanliness of air filter.
 - b. Check valve clearances.
 - c. Clean and check injectors.
3. Any repair which involves disassembly of the injection pump must be carried out by specially trained mechanics with the proper tools and test equipment.
NOTE: *All warranties on the engine become null and void if the injection pump seals are broken by unauthorized persons.*

COOLING SYSTEM - GENERAL

NOTE: *Be sure to close the sea-cock before working on the engine cooling system.*



CAUTION: *The cooling water in the engine reaches extremely high temperatures. You must use extreme caution when working on hot engines to avoid burns. Allow the engine to cool before working on the cooling system. Open the filler cap carefully, using protective clothing when the engine is warm.*

SP13. CHECK THE COOLANT LEVEL

1. Check the coolant level each day before starting the engine. Check the water level by removing the pressure cap from the expansion tank or radiator. The level should be at the filler cap sealing surface when the engine is cold.
2. The pressure valve in the filler cap releases when the pressure is approximately 7 PSI (0.5 bar). Use a cap pressure tester to check cap if you suspect it is faulty.

Servicing

SP14. COOLING SYSTEM FLUSHING

1. Flush the cooling system every 2500 hours or every 12 months, whichever comes first.
2. Generator sets:
 - a. Remove expansion tank cap and drain engine block.
 - b. Open block drain cock.
Remove coolant hose at water pump and lower the hose below the manifold.
 - c. Pour clean water into expansion tank until water coming from drains is free of discoloration and sediment. Let water drain completely. Close drains, reconnect water hose, and refill with recommended mixture.
3. Coolant Specifications:
Use 50% water / 50% ethylene glycol antifreeze mix. Antifreeze mixture is recommended as a good year-round coolant.
4. Check hoses and connections and repair any leakage.

SP15. HEAT EXCHANGER

1. Clean the heat exchanger core once a year or after 2500 hours of operation.
2. Drain expansion tank and heat exchanger.
3. Remove heat exchanger end covers and remove core.
4. Clean the inside of exchanger core tubes using a metal rod. Flush, inspect and clean again if necessary.
5. Reassemble. Fill the cooling system, start the engine and check for leaks.

SP17. RAW WATER PUMP

1. Change the seawater pump impeller every 1000 hours, or as needed.
2. Remove the pump end cover. Pry out the impeller using needle-nose pliers or two screwdrivers. Be sure you remove all pieces of failed impeller.
NOTE: Place some kind of protection under the screwdrivers in order not to damage the pump housing.
3. Clean the inside of the housing.
5. Press in the new impeller and place the sealing washers in the outer end of the impeller center if this has not already been done.
6. Replace the cover using a new gasket.
NOTE: Make sure that there is always an extra impeller and cover gasket in reserve on board.

GENERATOR ENDS

The maintenance and operation recommendations for the generator end are in a separate Owner's Manual. If you do not have one of these manuals, contact your local Northern Lights dealer.

ELECTRICAL SYSTEM - GENERAL

1. Never switch battery switch off or break the circuit between the alternator and batteries while the engine is running. Regulator damage can result.
2. Do NOT reverse the polarity of battery cables when installing the battery.
3. When welding on the unit, disconnect the regulator and battery. Isolate the leads.
4. Disconnect the battery cables when servicing the D.C. alternator.
5. Never test with a screwdriver, etc., against any terminal to see if it emits sparks.
6. Do not polarize the alternator or regulator.
7. A D.C. circuit breaker protects your control panel and wiring harness. It is located in the side of the generator junction box.

GLOW PLUGS

1. Each cylinder is supplied with a glow plug which serves to heat the combustion chamber.
2. To check the glow plugs, loosen the current carrying wire between the plus-poles of the glow plugs (Figure 19). Connect a D.C. test bulb between the plus-pole of the battery and the plus-pole of the glow plug. If the bulb lights up, the glow plug is functioning properly.
3. Check all glow plugs and replace any faulty ones.

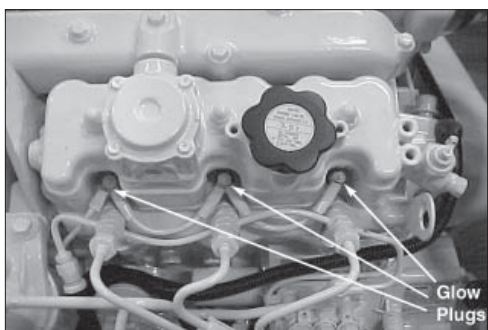

Figure 19: Glow plugs.

BOOSTER BATTERIES



CAUTION: *Battery gas can explode. Keep all flames and sparks away from batteries.*

1. Before changing or using booster batteries, check battery electrolyte level. Add distilled water if necessary.
2. Booster and main batteries must have the same voltage rating.
3. First, connect positive (+) terminal of booster battery to positive (+) terminal of main battery. Then, connect negative (-) terminal of booster battery to ground on the engine block (see Figure 20).
4. Remove booster battery after starting engine.
5. Sealed batteries: See manufacturer charging and booster instructions.

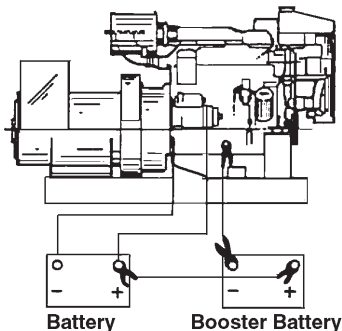

Figure 20:
Battery connections.

SP 18-19. BATTERY CARE

1. Check electrolyte level daily. Add distilled water to manufacturer's recommended level.
2. Batteries, cables and cable terminals should be checked and cleaned every 100 hours. Clean corrosion with a water and baking soda solution. Flush with clean water. Tighten terminals and grease them to inhibit corrosion.
3. Check the battery condition with a hydrometer every 250 hours.

SP20. WINTERIZING / OUT-OF-SERVICE

1. Generator sets:
 - a. Drain fresh water and seawater cooling systems completely. Remember to shut off seacocks before opening drain cocks.
 - b. Drain water supply lines and wet exhaust line.
 - c. Loosen the seawater pump cover and drain pump.
 - d. Change the crankcase oil and filter.
 - e. Loosen the alternator belt.
 - f. Disconnect and clean battery. Remove to warm storage place if possible.
 - g. Clean outside of unit. Paint any scratched or chipped surfaces. Put corrosion preventative on all exposed metal surfaces.

Troubleshooting

DC ELECTRICAL SYSTEM

PROBLEM	POSSIBLE CAUSE	RECOMMENDATION(S)
Battery Will Not Charge	Loose or corroded connections	• Clean and tighten battery connections.
	Sulfated or worn out batteries	• Check specific gravity of each battery. • Check electrolyte level of each battery.
	Loose or defective alternator belt	• Adjust belt tension. • Replace belt.
Starter Inoperative	Check DC circuit breaker	• If the breaker is tripped, reset it.
	Loose or corroded connections	• Clean and tighten loose battery and harness plug connection.
	Low battery output	• Check specific gravity of each battery. • Check electrolyte level of each battery.
	Defective electrical system ground wire:	• Repair or replace.
Starter Cranks Slowly	Low battery output	• Battery is too small. • Battery cables are too small.
	Check specific gravity of each battery	• Replace battery if necessary.
	Check electrolyte level of each battery	• If low, fill cells with distilled water.
	Crankcase oil too heavy	• Fill with oil of appropriate viscosity.
	Loose or corroded connections	• Clean and tighten loose connections.
Entire Electrical System Does Not Function	Check DC circuit breaker	• If breaker is tripped, reset it.
	Faulty connection	• Clean and tighten battery and harness plug connections.
	Sulfated or worn out batteries	• Check specific gravity and electrolyte level of each battery.

If you cannot correct problems with these procedures, see your **Northern Lights** dealer.

ENGINE

PROBLEM	POSSIBLE CAUSE	RECOMMENDATION(S)
Engine Hard to Start or Will Not Start	Improper starting procedure	<ul style="list-style-type: none"> • See starting section of this manual. Take special note of Bypass Switch operation.
	No fuel	<ul style="list-style-type: none"> • Check level of fuel in fuel tank.
	Low battery output	<ul style="list-style-type: none"> • Check electrolyte level and condition.
	Excessive resistance in starting circuit	<ul style="list-style-type: none"> • Clean and tighten all battery connections.
	Crankcase oil too heavy	<ul style="list-style-type: none"> • Use oil of proper viscosity.
	Improper type of fuel	<ul style="list-style-type: none"> • Consult fuel supplier and use proper type of fuel for operating condition.
	Water, dirt or air in fuel system	<ul style="list-style-type: none"> • Drain, flush, fill and bleed system.
	Clogged primary fuel filter element	<ul style="list-style-type: none"> • Clean or replace filter element.
	Clogged secondary fuel filter element	<ul style="list-style-type: none"> • Replace filter element.
	Dirty or faulty injection nozzles	<ul style="list-style-type: none"> • Have your dealer check injection nozzles.
Engine Runs Irregularly or Stalls Frequently	Below normal engine temperature	<ul style="list-style-type: none"> • Remove and check thermostat.
	Clogged primary fuel filter element	<ul style="list-style-type: none"> • Clean or replace filter element.
	Clogged secondary fuel filter element	<ul style="list-style-type: none"> • Replace secondary filter element.
	Water or dirt in the fuel system	<ul style="list-style-type: none"> • Drain, flush, fill and bleed system.
	Dirty or faulty injection nozzles	<ul style="list-style-type: none"> • Have your dealer check injection nozzles.
	Air in fuel system	<ul style="list-style-type: none"> • Inspect clamps and hoses on suction side of fuel pump for air leak.
	Improper type of fuel	<ul style="list-style-type: none"> • Consult fuel supplier and use proper type of fuel for operating condition.
Lack of Engine Power	Intake air restriction	<ul style="list-style-type: none"> • Service air cleaner.
	Clogged primary fuel filter element	<ul style="list-style-type: none"> • Clean or replace filter element.
	Clogged secondary fuel filter element	<ul style="list-style-type: none"> • Replace filter element.
	Improper type of fuel	<ul style="list-style-type: none"> • Consult fuel supplier and use proper type of fuel for operating conditions.
	Overheated engine	<ul style="list-style-type: none"> • See “Engine Overheats” in next category.
	Below normal engine temperature	<ul style="list-style-type: none"> • Remove and check thermostat.
	Improper valve clearance	<ul style="list-style-type: none"> • Reset valves. Best done by dealer.
	Dirty or faulty injection nozzles	<ul style="list-style-type: none"> • Replace injectors. Best done by dealer. • See your local dealer.

Troubleshooting

ENGINE

PROBLEM	POSSIBLE CAUSE	RECOMMENDATION(S)
Engine Overheats	Low coolant level	<ul style="list-style-type: none"> • Fill tank or radiator to proper level. • Check hoses for loose connections and leaks.
	Keel cooling tubes have been painted (marine)	<ul style="list-style-type: none"> • Remove paint from tubes.
	Cooling system needs flushing	<ul style="list-style-type: none"> • Flush cooling system.
	Defective thermostat	<ul style="list-style-type: none"> • Remove and check thermostat.
	Defective temperature gauge	<ul style="list-style-type: none"> • Check water temperature with thermometer and replace gauge if necessary.
	Water pump impeller worn/broken	<ul style="list-style-type: none"> • Check impeller and replace if necessary.
Engine Knocks	Insufficient oil	<ul style="list-style-type: none"> • Call your dealer.
	Injection pump out of time	<ul style="list-style-type: none"> • Call your dealer.
	Below normal engine temperature	<ul style="list-style-type: none"> • Check your thermostats. • Check water temperature to see if temperature gauge is working properly.
	Engine overheating	<ul style="list-style-type: none"> • See “Engine Overheating” section.
High Fuel Consumption	Improper type of fuel	<ul style="list-style-type: none"> • Use correct fuel for temperature.
	Clogged or dirty air cleaner	<ul style="list-style-type: none"> • Service air cleaner.
	Improper valve clearance	<ul style="list-style-type: none"> • See your dealer.
	Injection nozzles dirty	<ul style="list-style-type: none"> • See your dealer.
	Injection pump out of time	<ul style="list-style-type: none"> • See your dealer.
	Engine not at proper temperature	<ul style="list-style-type: none"> • Check your thermostats. • Check water temperature with thermometer and replace gauge if necessary.
Below Normal Engine Temperature	Thermostats not working properly	<ul style="list-style-type: none"> • Check thermostats.
	Temperature gauge not working properly	<ul style="list-style-type: none"> • Check water temperature with thermometer.
Low Oil Pressure	Low oil level	<ul style="list-style-type: none"> • Fill crankcase to proper level.
	Improper type of oil	<ul style="list-style-type: none"> • Drain and fill crankcase with correct oil.
	Partially plugged oil filter	<ul style="list-style-type: none"> • Replace filter.
High Oil Consumption	Break-in period	<ul style="list-style-type: none"> • Oil consumption decreases after break in.
	Crankcase oil too light	<ul style="list-style-type: none"> • Use proper viscosity oil.
	Oil leaks	<ul style="list-style-type: none"> • Check for leaks in lines around gaskets and drain plug.

If you cannot correct problems with these procedures, see your **Northern Lights** dealer.

ENGINE

PROBLEM	POSSIBLE CAUSE	RECOMMENDATION(S)
Engine Emits Black or Gray Exhaust Smoke	Clogged or dirty air cleaner	• Service air cleaner.
	Defective muffler (back pressure too high)	• Have dealer check back pressure.
	Improper fuel	• Use correct fuel for temperature.
	Injection nozzles dirty	• See your dealer.
	Engine out of time	• See your dealer.
Engine Emits White Smoke	Improper fuel	• Use correct fuel for temperature.
	Cold engine	• Warm up engine to normal operating temperature.
	Defective thermostat	• Remove and check thermostat.
	Engine out of time	• See your dealer.

If you cannot correct problems with these procedures, see your **Northern Lights** dealer.

Wiring Diagrams

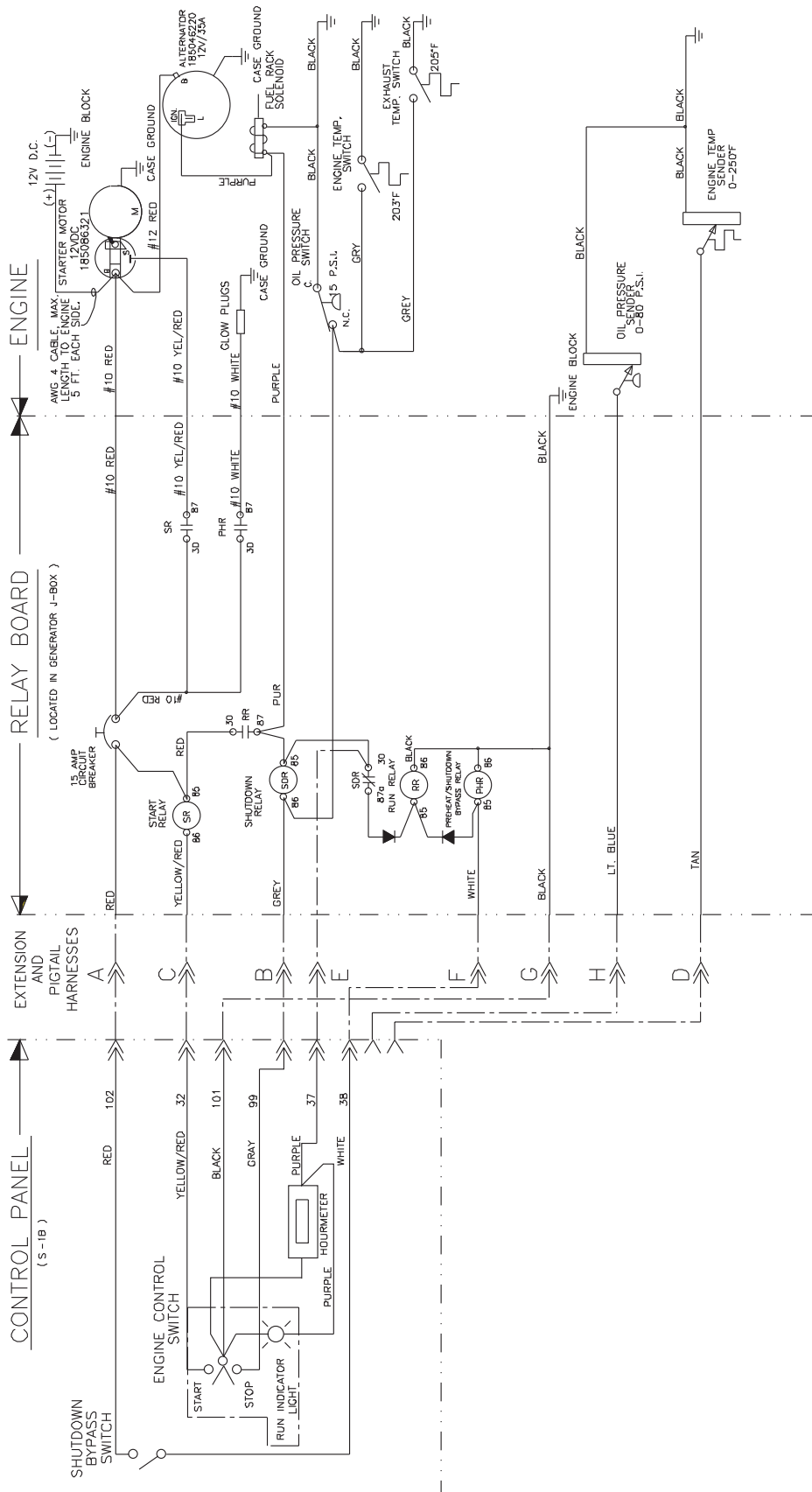

NOTES:

1. ALL INSTALLATION CONDUCTORS TO BE AWG 14, TYPE MTW, 105°C, MULTISTRAND, 600VAC, EXCEPT AS NOTED.
2. UNLESS COLOR CODED, ALL A.D.E. INSTALLED CONDUCTORS ARE TO BE GREY AND MUST BE IDENTIFIED BY WIRE MARKER AT EACH CONNECTION POINT.

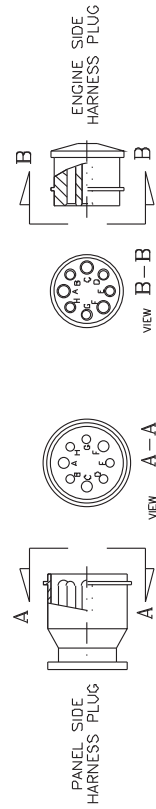

12 Volt DC Engine Wiring Diagram

Drawing #C-4907

*AC Wiring Diagrams can be found in the corresponding Generator Manual.
Wiring diagrams are subject to change without notice.



www.northern-lights.com

4420 14th Ave. NW., Seattle WA 98107

Tel: (206) 789-3880 • 1-800-762-0165 • Fax: (206) 782-5455

Northern Lights and Lugger are registered trademarks of Northern Lights, Inc.

© 2009 All rights reserved. Litho USA.