

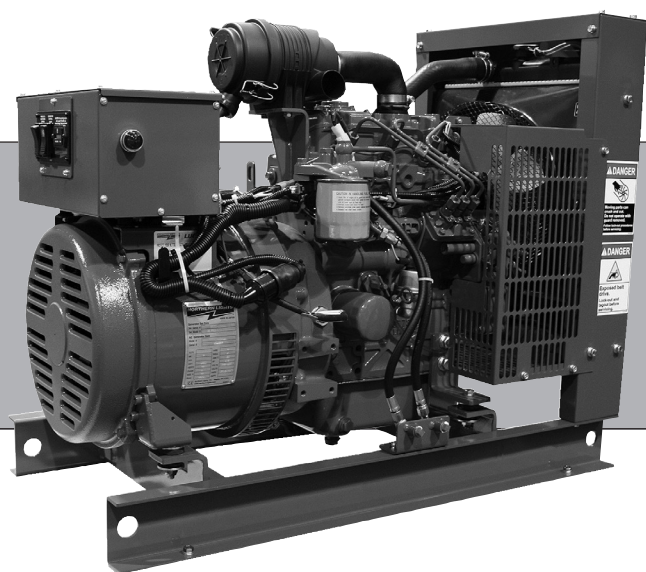

OPERATOR'S MANUAL

ONL773LW4

For Models: NL773LW4 and NL773LW4E



www.northern-lights.com

**ULTRA LOW
SULFUR FUEL
ONLY**

RE529956

As of January 2011, U.S. EPA regulations require the application of a permanently applied label near the fuel tank fill port for diesel driven equipment. This label is to state:

ULTRA LOW SULFUR FUEL ONLY

Northern Lights is providing this label for application to the fuel inlet of the fuel supply tank for each engine or generator set. This is to be applied by the installer of the engine or gen set, or by the manufacturer of the equipment that the engine or gen set is installed in. The location of the label must be in clear site of personnel that refill the supply tank.



— CALIFORNIA —
Proposition 65 Warning:

Breathing Diesel engine exhaust and some of its constituents are known to the State of California to cause cancer, birth defects, and other reproductive harm.

- * Always start and operate the engine in a well-ventilated area.
- * If in an enclosed area, vent the exhaust to the outside.
- * Do not modify or tamper with the exhaust system.
- * Do not idle the engine except as necessary.

For more information, go to www.P65warnings.ca.gov/diesel.

Northern Lights

4420 14th Avenue NW
Seattle, WA 98107
Tel: (206) 789-3880
Fax: (206) 782-5455

Copyright ©2018 Northern Lights, Inc.
All rights reserved. Northern Lights™, and
the Northern Lights logo are trademarks of
Northern Lights, Inc.

Printed in U.S.A.
PART NO.: ONL773LW4 04/20



OPERATOR'S MANUAL

for Model NL773LW4 and NL773LW4E

*Read this operator's manual thoroughly before starting to operate your equipment.
This manual contains information you will need to run and service your new unit.*

Table of Contents

<p>INTRODUCTION 2</p> <p style="padding-left: 20px;">Models Included 2</p> <p style="padding-left: 20px;">Model Numbers 2</p> <p style="padding-left: 20px;">Serial Numbers 2</p> <p>WARRANTY 3</p> <p>SAFETY RULES 3 - 7</p> <p>LOCK OUT / TAG OUT PROCEDURES 8</p> <p>COMPONENT LOCATIONS</p> <p style="padding-left: 20px;">Industrial Generator 9</p> <p>CONTROL PANEL</p> <p style="padding-left: 20px;">S-1B Control Panel 10</p> <p>OPERATING PROCEDURES</p> <p style="padding-left: 20px;">Break-in Period 11</p> <p style="padding-left: 20px;">Before Starting 11</p> <p style="padding-left: 20px;">Starting 11</p> <p style="padding-left: 20px;">Operating 11</p> <p style="padding-left: 20px;">Stopping 11</p> <p style="padding-left: 20px;">Shutdowns and Alarms 12</p> <p style="padding-left: 20px;">Spare Parts 12</p> <p>SERVICING SCHEDULE CHART 13</p>	<p>SERVICING</p> <p style="padding-left: 20px;">Lubrication - General 14</p> <p style="padding-left: 20px;">Checking Oil 14</p> <p style="padding-left: 20px;">Oil Changes 14</p> <p style="padding-left: 20px;">Changing Oil Filter 14</p> <p style="padding-left: 20px;">Air Filter 15</p> <p style="padding-left: 20px;">V-Belts 15</p> <p style="padding-left: 20px;">Valve Clearances 15</p> <p style="padding-left: 20px;">Fuels - General 16</p> <p style="padding-left: 20px;">Fuel Filters 16</p> <p style="padding-left: 20px;">Bleeding the Fuel System 17</p> <p style="padding-left: 20px;">Injector Service 18 - 19</p> <p style="padding-left: 20px;">Injection Pump 19</p> <p style="padding-left: 20px;">Cooling System - General 19</p> <p style="padding-left: 20px;">Cooling System Flushing 20</p> <p style="padding-left: 20px;">Clean Radiator 20</p> <p style="padding-left: 20px;">Generator End 20</p> <p style="padding-left: 20px;">Electrical System - General 20</p> <p style="padding-left: 20px;">Glow Plugs 21</p> <p style="padding-left: 20px;">Booster Batteries 21</p> <p style="padding-left: 20px;">Battery Care 21</p> <p style="padding-left: 20px;">Winterizing / Out-of-Service 21</p> <p>TROUBLESHOOTING</p> <p style="padding-left: 20px;">Electrical 22</p> <p style="padding-left: 20px;">Lamp Codes 23</p> <p style="padding-left: 20px;">Engine 24 - 26</p> <p>WIRING DIAGRAMS (Current Production)</p> <p style="padding-left: 20px;">AC Electrical 27 - 28</p> <p style="padding-left: 20px;">DC Electrical 29 - 33</p> <p>APPENDIX (Non-Current Production Diagrams)</p> <p style="padding-left: 20px;">DC Electrical 34 - 35</p> <p style="padding-left: 20px;">Panel Diagrams 36 - 37</p>
---	---

Proprietary Information

This publication is the property of Northern Lights, Inc.

It may not be reproduced in whole or in part without the written permission of Northern Lights, Inc.

© Northern Lights, Inc. All rights reserved. Litho U.S.A. Publication number ONL773LW4 04/20

Introduction

Servicing of industrial engines and generator sets presents unique problems. Generator sets cannot be compared to the servicing of automobiles, trucks or even farm equipment. Failures often occur in remote areas far from competent assistance.

Industrial engines are often taxed far more severely than auto or truck engines; therefore, maintenance schedules must be adhered to more strictly.

Failures begin with minor problems that are

overlooked and become amplified when not corrected during routine maintenance.

As operator, it is your obligation to learn about your equipment and its proper maintenance. This is not a comprehensive technical service manual. Nor will it make the reader into an expert mechanic. Its aim is to aid you in maintaining your unit properly.

Unit Identification

MODELS INCLUDED

This manual covers the operating instructions for:

NL773LW4 & NL773LW4E industrial generator sets.

Model Numbers

Model numbers give the unit's application, block model, aspiration, and RPM:

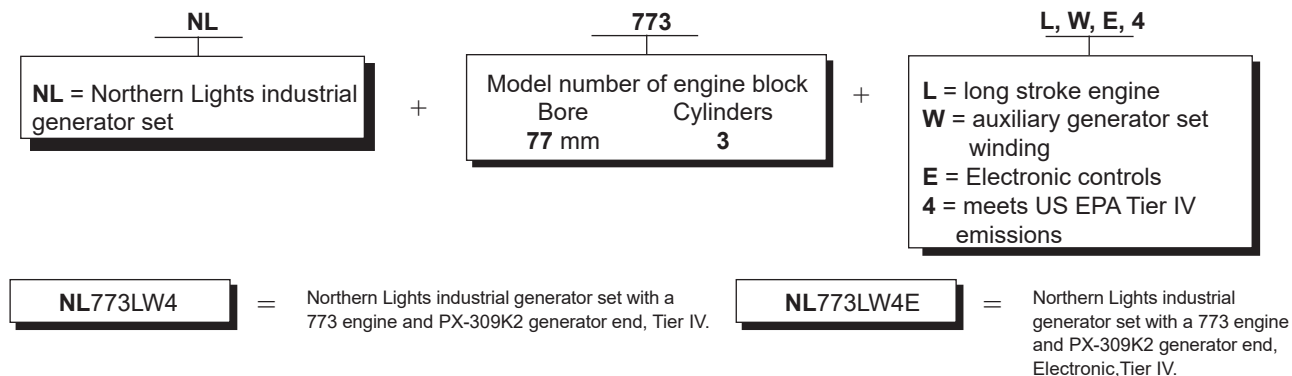

Serial Numbers



Your set has three serial numbers: ① an engine number stamped on the block, ② a generator plate, and ③ a generator set plate.

Use the serial number on the generator set plate when ordering parts or in correspondence. The generator set plate is found on the service side of the generator and resembles the drawing in Figure 1.

Figure 1: Generator set serial number plate.

Warranty

A warranty registration certificate is supplied with your set. The extent of coverage is described in the Limited Warranty Statement. We recommend that you study the statement carefully.

NOTE: If the warranty is to apply, the servicing instructions outlined in this manual must be followed. If further information is needed, please contact an authorized dealer or the factory.

Safety Rules



NOTICE: Accident reports show that careless use of engines causes a high percentage of accidents. You can avoid accidents by observing these safety rules. Study these rules carefully and enforce them on the job.

IMPORTANT SAFETY INSTRUCTIONS.

Electromagnetic equipment, including generator sets and their accessories, can cause bodily harm and life threatening injuries when improperly installed, operated or maintained. To prevent accidents be aware of potential dangers and act safely.



READ AND FOLLOW ALL SAFETY INSTRUCTIONS IN THIS MANUAL, PRIOR TO THE INSTALLATION OF ANY GENERATOR SET OR

ACCESSORY. KEEP THESE INSTRUCTIONS FOR FUTURE REFERENCE.

Recognize Safety Symbols and Instructions

In addition to the information found in this section, this operator's manual uses three different signal words to outline potential dangers of a specific nature.



DANGER DANGER indicates a hazardous situation which, if not avoided, will result in death or serious injury.



WARNING WARNING indicates a hazardous situation which, if not avoided, could result in death or serious injury.



CAUTION CAUTION indicates a hazardous situation which, if not avoided, could result in minor or moderate injury.

Follow All Safety Instructions

Carefully read and understand all safety messages in this manual and on your machine's safety signs. Keep signs in good and clean condition. Replace missing or damaged signs. Be sure new equipment components and repair parts include the current safety signs. For replacement signs, proper placement of safety signs or clarification on any safety issue, consult your Northern Lights dealer or the factory. There can be additional safety information contained on parts and components from outside suppliers that is



not reproduced in this manual. Consult the suppliers for additional safety information.

Learn how to operate the machine and how to use the controls properly. Only trained personnel should operate machines, or work on or around them.

Keep you machine in proper working condition. UNAUTHORIZED MODIFICATIONS TO THE MACHINERY MAY IMPAIR ITS FUNCTION AND SAFETY PARAMETERS.

Prevent Bypass and Accidental Starting



Do not start engine by shorting across start terminal. Engine will start if normal circuitry is bypassed, creating a hazard by runaway machinery.



Start engine only from operator's station.

Handle Fuel Safely - Avoid Flames



Diesel is highly flammable and should be treated with care at all times. Do not refuel while smoking or when near sparks or open flame.

ALWAYS STOP ENGINE BEFORE FUELING MACHINE. Always fill portable fuel tank outdoors. Never fuel a hot engine.



Safety Rules (Continued)

Prevent accidental discharge of starting fluids by storing all cans in a cool, safe place, away from sparks or open flame. Store with cap securely on container. Never incinerate or puncture a fuel container.

Prevent fires by keeping machine clean of accumulated trash, grease and debris. Always clean any spilled fuel as swiftly as possible. Do not store oily rags, which can ignite and burn spontaneously.

Be prepared if a fire starts. Keep a first aid kit and fire extinguisher handy. Keep emergency contact numbers for fire department, doctors, ambulance and hospital near the telephone.

Service Machines Safely

! DANGER

Do not wear a necktie, scarf, necklace, rings or other jewelry, or any loose clothing when working near moving parts. Tie long hair behind your head. If any of these items get caught in moving machinery, severe injury or death could result.

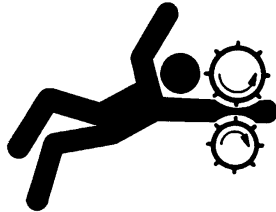

Check for any loose electrical connections or faulty wiring.

Look completely around engine to make sure that everything is clear before starting.

Wear Protective Clothing

! WARNING

To prevent catching anything in moving machinery, always wear close fitting clothes and safety equipment appropriate to the job.

Prolonged exposure to loud noise can cause hearing loss or impairment.

Wear suitable authorized hearing protection, such as earmuffs or plugs to protect against loud noises

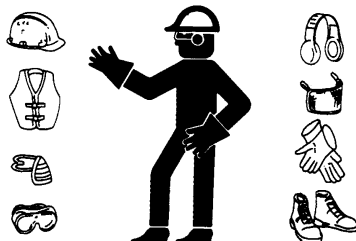

Operating equipment requires the full attention of the operator. Do not use radio or music headphones while operating machinery.

Practice Safe Maintenance

! CAUTION

Understand all service procedures before starting work. Keep area clean and dry. Never lubricate, service, or adjust machine while it is in operation.



Keep hands, feet and clothing away from power-driven equipment. When shutting down an engine, disengage all power and operator controls. Allow the engine to cool completely before beginning any service work.

Securely support any machinery elements that must be raised for service work with support or lifting machinery specifically intended for that purpose.

Keep all parts in good conditions and properly installed. Fix damage immediately. Replace any worn or broken parts. Remove any build up of grease, oil or debris.

Disconnect battery ground cable (-) before making any adjustments or service work.

Stay Clear of Rotating Drivelines

! DANGER

Entanglement in rotating drivelines can cause serious injury or death. Keep shields in place at all times. Make sure that rotating shields turn freely in pace with the drivelines.

Do not wear loose fitting equipment around rotating drivelines. Stop the engine and make sure that all moving parts have stopped before making any adjustments, connections, or performing any other type of service to the engine or other driven equipment.



Safety Rules (Continued)

Install all Safety Guards



Direct contact with rotating fans, belts, pulley and drives can cause serious injury.

Keep all guards in place at all times during engine operation.

Wear close-fitting clothes. Stop the engine and be sure all fans, belts, pulleys and drives are stopped before making adjustments, connections, or cleaning near fans and their components.

Do not allow anything on your person to dangle into or come in contact with a moving fan, belt, pulley or drive. Fans can act as vacuums and pull materials up from below, so avoid that area as well while in service.

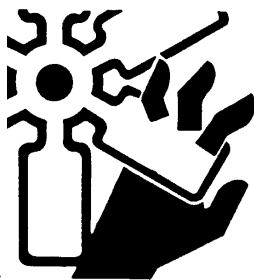

Safe Battery Handling



Prevent Battery Explosions

Battery gas is highly flammable. Battery explosions can cause severe injury or death. To help prevent battery explosions, keep sparks, lighted matches and open flame away from the top of battery. When checking battery electrolyte level, use a flashlight.

Never check battery charge by contacting the posts with a metal object. Use a volt-meter or hydrometer.

Frozen batteries may explode if charged. Never charge a battery that has not been allowed to warm to at least 16°C (60°F).

Always remove grounded (-) battery clamp first and replace ground clamp last.

Sulfuric acid in battery electrolyte is poisonous and strong enough to burn skin, eat holes into clothing and other materials, and cause blindness if splashed into eyes.



To Avoid Hazards:

- Fill batteries only in well-ventilated areas.
- Wear appropriate eye protection and rubber gloves.
- Never use air pressure to clean batteries.
- Wear appropriate ventilation equipment to avoid inhaling fumes when adding electrolyte.
- Do not spill or drip electrolyte.
- Use correct jump-start procedure if required.

If acid is spilled on skin or in eyes:

1. Flush skin with water.
2. Apply baking soda or lime to help neutralize acid.
3. Flush eyes with water for 15-30 minutes.
4. Get medical attention immediately.

If acid is swallowed:

1. DO NOT induce vomiting.
2. Drink large amounts of water or milk, without exceeding 2 liters (2 quarts)
3. Get medical attention immediately

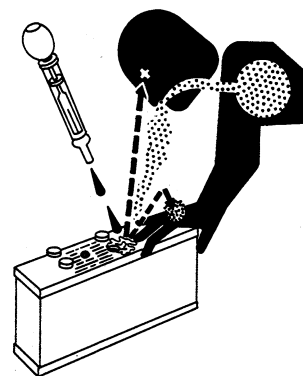

Battery posts, terminals, and related accessories can contain lead and lead compounds, chemicals known to the State of California to cause cancer and reproductive harm. Wash hands after handling.

Handle Chemical Products Safely



Direct exposure to hazardous chemicals can cause serious injury. Among the potentially hazardous chemicals that may be used with Northern Lights products are lubricants, coolants, paints and adhesives.

All potentially hazardous chemicals come with a Material Data Safety Sheet (MSDS). The MSDS provides specific details on chemical products, including physical hazards, safety procedures and emergency response techniques



Safety Rules (Continued)

Read and understand the MSDS for each chemical before you start any job that includes it. Follow the procedures and use appropriate equipment exactly as recommended.

Contact your Northern Lights dealer or Northern Lights factory for MSDS's used on Northern Lights products.

Work in Well Ventilated Areas

CAUTION

Exhaust fumes from engines contain carbon monoxide and can cause sickness or death. Work in well ventilated areas to avoid prolonged exposure to engine fumes. If it is necessary to run an engine in an enclosed area, route the exhaust fumes out of the area with an approved, leak proof exhaust pipe extension.

Remove Paint Before Welding or Heating

WARNING

Hazardous fumes can be generated when paint is heated by welding, soldering or using a torch. To avoid potentially toxic fumes and dust, remove paint before heating.

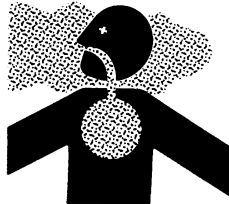

- Remove paint a minimum of 100 mm (4 in.) from the area that will be affected by heat.
- If paint cannot be removed, wear an approved respirator.
- If you sand or grind paint, use an approved respirator.
- If you use solvent or paint stripper, remove stripper with soap and water before welding. Remove solvent or paint stripper containers from the area.
- Allow at least 15 minutes for fumes to disperse before welding or heating.

Do not use a chlorinated solvent in an area where welding will occur. Work only in areas that are well ventilated. Dispose of paint and solvent properly.

Service Cooling System Safely

WARNING

Opening a pressurized cooling system can release explosive fluids and causing serious burns. Before opening any pressurized cooling system, make sure the



engine has been shut off. Do not remove a filler cap unless it is cool enough to comfortably grip with bare hands. Slowly loosen cap to relieve pressure before opening fully.

Avoid High Pressure Fluids

WARNING

Relieve pressure prior to disconnecting pressurized lines. Escaping fluid under pressure can penetrate the skin causing serious injury. Always relieve pressure before disconnecting hydraulic or other pressurized lines. Tighten all connections firmly before re-applying pressure.



If searching for leaks, use a piece of cardboard. Always protect your hands and other body parts from high-pressure fluids.

If an accident occurs, see a doctor immediately. Any high pressure spray injected into the skin must be removed within a few hours to prevent the risk of gangrene or other infection.

Avoid Heating Near Pressurized Fluid Lines

WARNING

Flammable spray can be generated by heating near pressurized fluid lines, resulting in severe burns and bodily injury. Pressurized lines can rupture when heat goes beyond the immediate flame area. Do not weld, solder or use a torch or open flame near pressurized lines or other flammable fluids.



Do Not Open High-Pressure Fuel System

DANGER

Many Northern Lights engines use high-pressure fuel injection. High-pressure fluid remaining in fuel lines can cause serious injury. Do not disconnect or attempt any repair of fuel lines, sensors, or other

Safety Rules (Continued)

components between the high-pressure fuel pump and nozzles on engines with high pressure fuel systems.

 **ONLY AUTHORIZED TECHNICIANS CAN PERFORM REPAIRS ON AN HIGH PRESSURE FUEL INJECTION SYSTEMS.**

Avoid Hot Exhaust

 **WARNING**

Avoid exposure to and physical contact with hot exhaust gases. Exhaust parts and streams can reach high temperatures during operation, leading to burns or other serious injury.



Cleaning exhaust filters can also lead to exposure to hot exhaust gas and the injury risk associated with it. Avoid exposure to and physical contact with hot exhaust gases when cleaning exhaust filters.

During auto or manual/stationary exhaust filter cleaning operations, the engine will run at elevated temperatures for an extended period of time. Exhaust parts and streams can reach high temperatures during operation, leading to burns or other serious injury.

Avoid Harmful Asbestos Dust

 **WARNING**

Inhaling asbestos fibers may cause lung cancer. Avoid breathing any dust that may be generated when handling components containing asbestos fibers, including some gaskets.

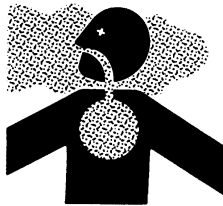

The asbestos used in these components is usually found in a resin or otherwise sealed. Normal handling of these components is not dangerous, as long as airborne dust containing asbestos is not generated.

Avoid creating dust. Never use compressed air for cleaning. Avoid brushing or grinding materials containing asbestos. When servicing, wear an approved respirator. A special vacuum cleaner is recommended to clean asbestos. If this vacuum is not available, apply a mist of oil or water on the

material containing asbestos. Keep all bystanders away from any area where asbestos dust may be generated.

Use Proper Lifting Equipment and Techniques

 **WARNING**

Lifting heavy components incorrectly can cause severe injury or damage to machinery. Avoid unbalanced loads. Do not use lifting eyes. Lift the generator set using lifting bars inserted through the lifting holes on the skid. Follow all recommended removal and installation procedures in this and associated Northern Lights manuals.

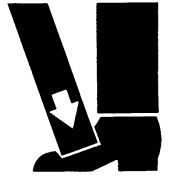

Use Proper Tools

 **CAUTION**

Makeshift tools and procedures can create safety hazards. Always use appropriate tools for the job.



Use power tools only to loosen threaded parts and fasteners. For loosening and tightening hardware, always use the correct sized tools.

Do not use US measurement tools on metric fasteners, or vice versa. Use only service parts that meet Northern Lights specifications.

Dispose of Waste Properly

 **CAUTION**

Disposing of waste improperly can threaten the environment and lead to unsafe working conditions. Potentially harmful waste used in Northern Lights equipment can include oil, fuel, coolant, filters and batteries.

Use leakproof containers to drain fluid. Do not use food or beverage containers that may mislead someone into drinking from them.

Do not pour waste onto the ground, down a drain or into any water source.

Lock Out / Tag Out Procedures

Scope

During maintenance, repairs or retooling of a Northern Lights generator set, simply turning the machine off or unplugging it while it is being worked on does not give enough protection to others who are not performing the maintenance or repair. Many serious accidents happen when someone thought the machine was turned off, or all of its energy was safely blocked or released.

General Policy

CAUTION

To avoid dangerous or hazardous situations, refrain from any of the following:

- Removing or bypassing a guard or other safety device
- Placing any part of your body in a position where you could be caught by moving machinery.
- Cleaning or oiling machinery when in operation.
- Adjusting circuits, chillers, pumps, air handlers, valves, circuit breakers or fans while in operation.
- Working on piping or high pressure systems.

Lock Out/Tag Out Instructions - Electrical Equipment

WARNING

Be sure the equipment's ON/OFF switch is in the OFF position and is unplugged from any electrical source before attempting to perform any type of work on the equipment. Obtain an electrical plug cap cover with a lockset. Secure the plug terminal end using the electrical plug lockout cap. Lock the cap and retain the key.

If the equipment is directly wired into an electrical box with a shut off switch, obtain a lock pad and/or the appropriate colored tags and place the lock and tag through the shut off lever. Retain the key until the repair is completed and the machine is safe to start. Be certain the shut off lever is in the OFF position before restarting. NEVER give a lock out key to unauthorized personnel.

If the equipment is directly wired into an electrical box without a shut off switch and lock out capability, then a circuit breaker lock out will be required. Obtain a circuit lock and tag set. Install the lock onto the circuit breaker box. Ensure the unit ON/OFF switch is in the OFF position before restarting.

Lock Out/Tag Out Instructions - Pneumatic and Hydraulic Equipment

WARNING

For servicing pneumatic and hydraulic equipment, the following additional procedures must be implemented, following completion of lock out/tag out procedures for the unit to be serviced:

Shut off air, water or supply valves at the equipment to be serviced.

Check the local bleed-off point for completed release of pressurized air, water or oil.

If shutting off of air, water or other material cannot be achieved at the local supply valve, shut off valves further back in the system and re-check the bleed-off point until complete shut-off is achieved.

Affix a DO NOT OPERATE tag to each valve handle that requires shut off. Each DO NOT OPERATE tag must be signed and dated by the authorized technician servicing the equipment.

Lock Out/Tag Out Instructions - Air Hose Connected Pneumatic Equipment

WARNING

Equipment connected to the compressed air system through an air hose with a detachable fitting must be shutdown and unplugged. Excess air must be bled prior to removing the air hose, prior to any maintenance or repair activities.

Affix a DO NOT OPERATE tag to the air hose near the detachable fitting. Each DO NOT OPERATE tag must be signed and dated by the authorized technician servicing the equipment. Check that the equipment cannot be operated by activating the ON switch.

Stored Energy

WARNING

Immediately after applying Lock Out or Tag Out devices, ensure that all potentially hazardous stored or residual energy is relieved, disconnected, restrained and otherwise rendered safe.

Verification of Isolation

CAUTION

Verify the machinery or equipment is actually isolated and de-energized prior to beginning work on a machine or on equipment that has been locked out.

Restarting Procedures

CAUTION

Follow the procedures below prior to restoring energy:

- Ensure that all machinery or equipment is properly reassembled. Inspect the machinery or equipment to verify non-essential items have been removed.
- Ensure that all personnel are safely outside danger zones. Notify personnel that lock out/tag out devices have been removed and energy will be reapplied.
- Only authorized personnel may remove lock out/tag out devices or notices.

Industrial Generator Component Locations

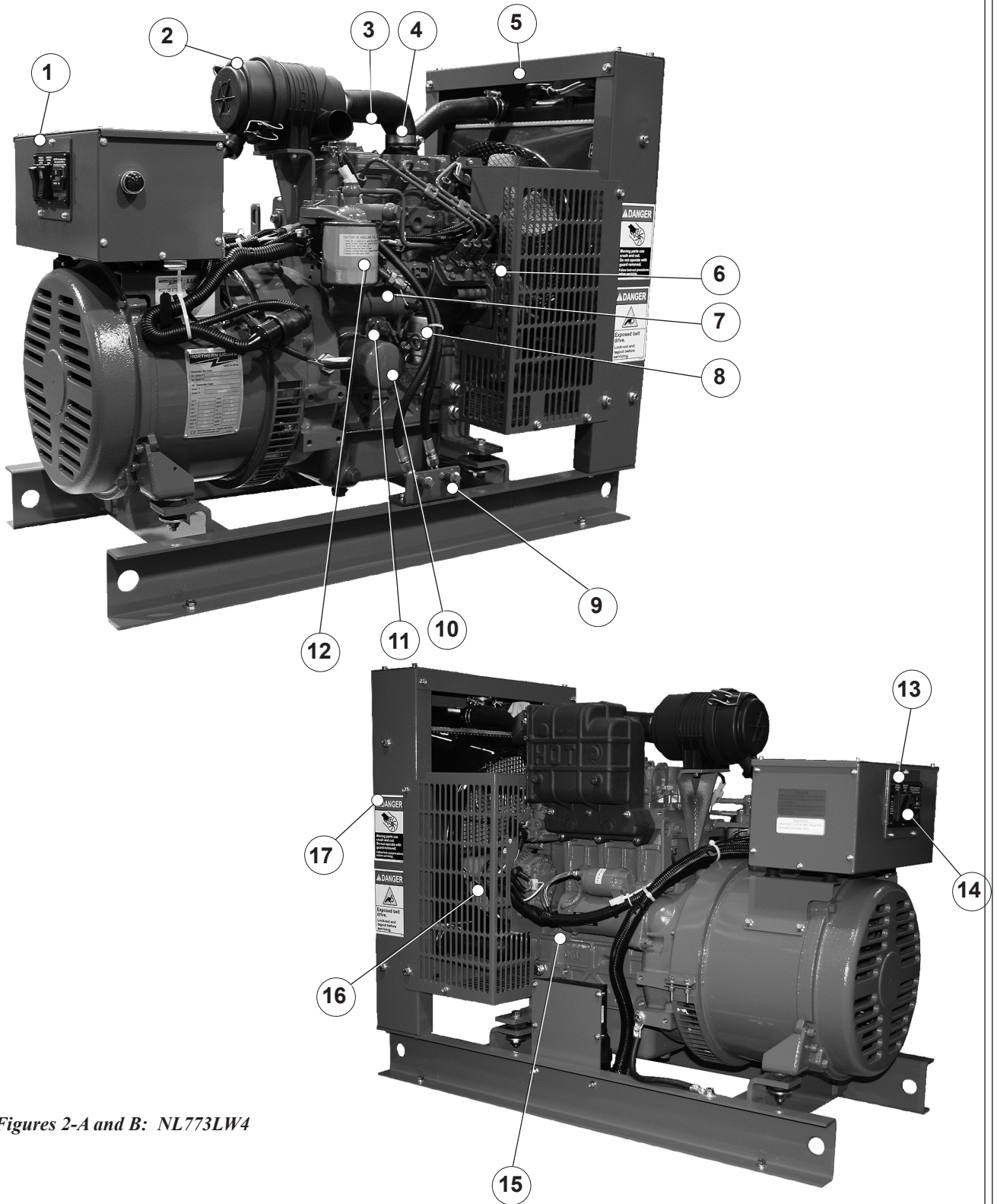

Figures 2-A and B: NL773LW4

- | | | |
|-------------------|---------------------------|---------------------|
| 1. Junction Box | 7. Fuel Lift Pump | 13. Hourmeter |
| 2. Air Filter | 8. Dipstick | 14. Control Panel |
| 3. Crankcase Vent | 9. Fuel Inlet and Return | 15. Starter |
| 4. Lube Oil Fill | 10. Oil Filter | 16. Alternator |
| 5. Coolant Fill | 11. Block Water Drain | 17. Radiator Shroud |
| 6. Injection Pump | 12. Secondary Fuel Filter | |

Control Panel

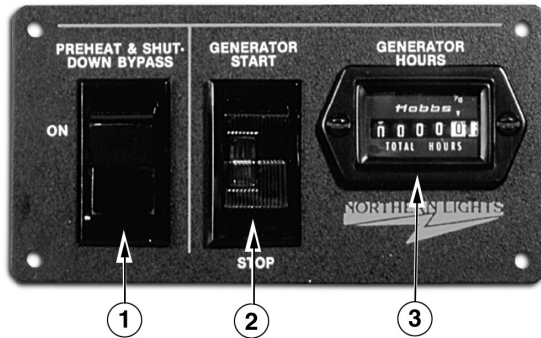

Figure 3: Series 1-B Generator Control Panel

1. SHUTDOWN BYPASS-PREHEAT SWITCH

There are two functions built into this switch: preheating the engine and bypassing the engine safety shutdown circuit, enabling a quicker start. Hold the switch in the ON position for approximately 10 to 20 seconds before starting a cold engine. Holding the switch ON for too long can burn out the glow plugs.

NOTE: Three position Engine Control switches must be in the RUN position during preheating. Preheat switch must be held in ON position during starting.

2. ENGINE CONTROL SWITCH

To start the engine, hold this switch in the START position until the engine is running.

After the engine starts, release the switch and it will return to RUN position. To stop the engine, hold the switch in the STOP position.

NOTE: The rocker switch has a light that glows when the set is running.

3. HOUR METER

Keeps track of engine running time.

Operating Procedures

BREAK-IN PERIOD

1. The first 100 hours on a new or reconditioned engine are critical to its life and performance.
2. Operate the engine under various conditions, particularly heavy loads with minimal idling, to help seat engine components properly.
3. Constantly check the engine temperature and oil pressure.
4. Oil consumption is greater during break-in as piston rings take time to seat.
5. Break-In Oil Changes: Change engine oil and filter at 50 hours. Change oil and filter again at 250 hours (consult Lubricants section for oil recommendation).

BEFORE STARTING

1. Check the water level by removing the pressure cap from the expansion tank or radiator. In order to give the cooling water an opportunity to expand, the level should be about 1 in. (2.5 cm) below the filler cap sealing surface when the engine is cold.

CAUTION: *Use protective clothing and open the filler cap carefully when the engine is warm to prevent burns.*



2. Check the oil level in the crankcase with the dipstick. The oil level must be in the waffled area on the stick. Never allow the level to go below this area. Always add the same viscosity of oil as is already in the crankcase.
3. Check the fuel tank level and open any fuel valves.

NOTE: *The battery switch must always be kept ON while the engine is running. If the switch is turned OFF while the engine is running, the battery charging regulator could be ruined.*

STARTING

1. Hold the Shutdown Bypass-Preheat switch in the ON position for 10 to 20 seconds before starting a cold

engine. Holding the switch too long can burn out the glow plugs. This step is not necessary if the engine is already warm.

2. While holding the Shutdown Bypass-Preheat switch in the ON position, push the Engine Control switch to the START position.
3. As soon as the engine starts, release both switches. Do not crank the starter for more than 20 seconds consecutively. If the engine fails to start with the first attempt, be sure that it has stopped completely before re-engaging.

OPERATING

1. Check oil pressure often. Oil pressure must be above 15 PSI. The water temperature must be below 225°F (107°C). Check the AC voltage and frequency. If these deviate from normal levels, shut down the generator set and investigate.
1. Let the unit run unloaded for a three to five minute warm-up period.
2. Add electrical load.

STOPPING

1. Remove electrical load from the generator set.
2. Move the Engine Control switch to the STOP position momentarily.

SHUTDOWNS AND ALARMS

1. Generator sets have shutdown systems to stop the engine in the event of high water temperature or low oil pressure.

Other alarms and shutdowns are available as optional equipment.

NOTE: *Do not rely on your shutdown to the exclusion of careful gauge monitoring. Watching your gauges can prevent damage to the unit and dangerous power losses.*

Operating Procedures

2. Electronically-controlled generator sets will run at reduced capacity when the Engine Control Unit (ECU) detects a problem with one of its sensors. These problems are indicated by a flashing trouble code on the ECU warning light. For the NL676L4E, see Figure 16 on page 23 for the meaning of different codes.
3. Do the following when your warning or shutdown system is activated:
 - a. Check the temperature gauge.
Industrial sets: If above 230°F (110°C), shut off the engine immediately.
 - b. Use the Trouble Shooting Guide on page 21 to isolate the cause of the overheat.



CAUTION: *Do not remove the water fill cap of an overheated engine. Escaping high temperature steam can cause severe burns. Allow the engine to cool and then remove the cap slowly using protective clothing.*

- c. Make repairs.
Restart your Industrial set after the temperature gauge registers below 225°F (107°C).
- d. Watch the temperature gauge regularly and turn off the unit if the temperature rises above 230°F (110°C) on Industrial sets. Repeat trouble shooting.
3. If shutdown is activated and the temperature gauge shows temperature within normal temperature range:
 - a. Check the engine crankcase oil level.
 - b. If the oil level is low, fill with recommended lubricating oil and restart. Watch the oil pressure gauge carefully and shut off the engine if it does not show a normal reading (20-60 PSI) after a few seconds of operation.
 - c. If the oil level is normal, DO NOT restart the engine. Call your dealer for assistance.

4. If the ECU is indicating a trouble code
 - a. Record the code and shut off the engine.
 - b. Refer to Figure 16 on page 23 and the DC wiring diagram to determine the problem.
 - c. Repair the problem and restart the engine.

SPARE PARTS

1. Northern Lights recommends that you keep the following spare parts on hand for field service. The parts are available from your local Northern Lights dealer.
 - a. **Primary and secondary fuel filter elements**
 - b. **Oil filters**
 - c. **Air filter**
 - d. **Alternator belt**
 - e. **Thermostat and gaskets**
 - f. **Glow plug**
 - g. **Injector and washer**
2. All owners should have the following:
 - a. **Complete set of injectors**
 - b. **Copper washers for injector change**
 - c. **Complete set of glow plugs**
 - d. **Fuel lift pump**
3. If your set is operating a long distance from a servicing dealer, add the following:
 - a. **Complete set of injectors**
 - b. **Copper washers for injector change**
 - c. **Complete set of glow plugs**
 - d. **Fuel lift pump**

Servicing Schedule Chart

The Servicing Schedule Chart below shows the service schedule required for proper maintenance of your generator set. More detailed coverage of each Service Point (SP) is listed on the page noted in the 'page' column.

DAILY:

- SP1 Check oil level in engine
- SP5 Check V-belt tension
- SP7 Check primary fuel filter
- SP13 Check coolant level
- SP18 Check electrolyte in batteries

AFTER FIRST 50 HOURS:

- SP2/3 Change engine oil and filter
- SP6 Adjust valves

AFTER FIRST 100 HOURS:

- SP2/3 Change engine oil and filter

EVERY 250 HOURS:

- SP2/3 Change engine oil and filter
- SP4 Check air cleaner
- SP16 Check and clean radiator
- SP19 Check state of charge of batteries

EVERY 500 HOURS:

- SP2/3 Change engine oil and filter
- SP8 Change primary fuel filter element
- SP9 Change secondary fuel filter

EVERY 1000 HOURS:

- SP4 Change air cleaner element
- SP6 Check valve clearances
- SP11 Check injectors

EVERY 2500 HOURS:

- SP12 Check fuel injection pump
- SP14 Check and flush cooling system

SERVICE POINT	PAGE	OPERATION	DAILY	50 Hours	250 Hours	500 Hours	1000 Hours	2500 Hours
		ENGINE:						
SP1	8 & 12	Check oil level	•					
SP2	12	Change engine oil 1) 5)			•			
SP3	12	Change lube oil filters 1) 5)		•	•			
SP4	13	Check air cleaner 1) 4)			•			
SP5	13	Check V-belt tension	•					
SP6	13	Check valve clearances 1) 2)					•	
		FUEL SYSTEM:						
SP7	14	Check primary filter (Racor) 2) 3)	•					
SP8	14	Change primary filter element (Racor) 2) 3)				•		
SP9	14	Change secondary fuel filter 1) 3)				•		
SP10	15	Bleed the fuel system 3)						
SP11	17	Check injectors 1) 3) 6) 7)					•	
SP12	17	Check fuel injection pump 7)						•
		COOLING SYSTEM:						
SP13	8 & 17	Check coolant level	•					
SP14	18	Check and flush cooling system						•
SP16	18	Check and clean radiator fins			•			
		ELECTRICAL SYSTEM:						
SP18	19	Check electrolyte level in batteries 1) 4)		•				
SP19	19	Check condition of batteries with hydrometer 1) 4)			•			
		OUT OF SERVICE:						
SP20	19	Winterizing or out-of-service 3)						

- 1) Perform all maintenance once a year even if hour level has not been reached.
- 2) Consult manufacturer's maintenance schedule, note on chart.
- 3) Whenever necessary.
- 4) More often if necessary.
- 5) After first 50 hours, then after 100 hours, then at every 250 hours.

- 6) Clean injection nozzles every 1500 hours.
- 7) **For EPA emission standards fuel nozzle needs to be cleaned every 1500 hours, the fuel nozzle and fuel pump need to be cleaned, adjusted, or repaired every 3000 hours, and the quality guarantee for these parts is 1500 hours or 2 years.**

Servicing

LUBRICATION - GENERAL

1. Use only clean, high quality lubricants stored in clean containers in a protected area.
2. These lubricants are acceptable:
 - a. API Service CC/CD/CE single viscosity oils.
 - b. API Service CC/CD/SF multi-viscosity oils.
3. Use the proper weight oil for your average operation temperature.

Air Temperature	Single Viscosity	Multi-Viscosity
Above 32°F (0°C)	SAE 30W	SAE 15-40W
-10 to 32°F (-23 to 0°C)	SAE 10W	SAE 10-30W
Below -10°F (-23°C)	SAE 5W	SAE 5-20W

Figure 4: Lube Oils

4. Some increase in oil consumption may be expected when SAE 5W and SAE 5-20W oils are used. Check oil level frequently.
5. Never put additives or flushing oil in crankcase.

SP1. CHECKING OIL LEVEL

1. Check the oil level in the crankcase with the dipstick. The oil level must be in the waffled area on the stick. Never allow the level to go below this area. Follow the lubrication recommendations above.

SP2. OIL CHANGES

1. The set is delivered with special break-in oil. Change the engine oil and oil filter after 50 hours of operation. Use Service CC 30 weight oil during the first 100 hours.
2. Change the oil and filter again at 100 hours using the oil recommended in Figure 4. After this, change oil and filter every 200 hours.
3. During intermittent cold weather operation, change oil every 100 hours or six weeks, whichever comes first.
4. Change oil at any seasonal change in temperature when a new viscosity of oil is required.
5. Change oil when engine is warm.
6. Dispose of waste oil in an approved manner.
7. Never use a flushing oil.
8. Loosen the clamp on the oil change tube. Remove cap. Drain oil. Replace the cap and tube.
9. Refill engine with recommended oil.
10. Engine capacity with new oil filter is:
4.8 quarts (4.5 liters)

SP3. CHANGING LUBE OIL FILTER

1. Change the lube oil filter every 200 hours.
2. Use a filter wrench to remove old filter. Dispose of filter in approved manner.
3. Make sure the gasket from the old filter is removed and discarded. Clean mount face.
4. Spread a thin film of engine oil on the rubber gasket on the new filter and screw it on nipple until gasket meets the sealing surface.
5. Using hands only – no wrench – tighten filter one-half turn farther. Overtightening can do damage to filter housing.
6. Fill engine with recommended oil. Start engine and check for leakage. Stop engine, wait 3 minutes, and check oil level. Add additional oil if necessary.
7. The oil filter part number is:
#24-02001

Servicing

SP4. AIR CLEANER

1. Inspect air cleaner every 200 hours. In dusty conditions, check more often.
2. Industrial sets: the element cannot be cleaned. Replace it when necessary. Part numbers are:
NL773LW3 – #24-27301

4. **NOTE: Make absolutely sure no impurities enter the engine while changing the element. Do NOT run the engine with the air cleaner removed.**

SP5. V-BELTS

1. Check the tension and wear on the V-belt daily.
2. Use your thumb to press on the belt at the midpoint between the crankshaft and alternator pulleys. The tension is correct if the belt can be depressed about 3/16 in. (5 mm).

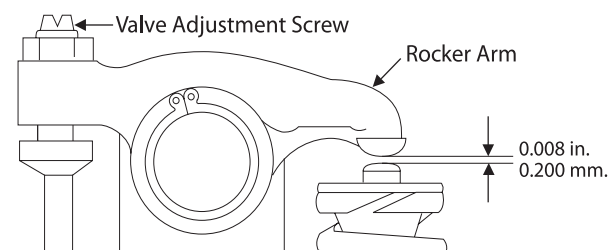

Figure 5: Valve Adjustment

SP6. VALVE CLEARANCES

1. Adjust valve clearance after 1000 hours of operation or as needed.
2. Valve adjustments should be done after the cylinder head bolts have been re-tightened. Engine should be cold and NOT running.
3. Watch the valves while turning the engine over by hand. Turn until the inlet valve starts to open and the exhaust valve starts to close (the valves are rocking). Then turn the crankshaft one more full turn and adjust the clearance on both valves for this cylinder.
4. Loosen the lock nut and adjust the clearance between the rocker arm and valve guide of both the intake and exhaust valves with the adjustment screw (Figure 5). Clearance on both intake and exhaust valves should be 0.008 in. (0.2 mm).
5. Repeat steps 3 and 4 for each cylinder. Each set of valves must be adjusted individually.
6. Replace the rocker arm cover. Tighten cover nuts to 5 - 8 ft/lbs (0.8 - 2.3 kg/m).

Cylinder No.	1		2		3	
	Intake	Exh.	Intake	Exh.	Intake	Exh.
When No. 1 Cylinder is at TDC in Compression Stroke	○	○		○		
With the Crankshaft turned by 360° in normal direction from above			○		○	○

Valve Sequence

Servicing

FUELS - GENERAL

1. Use only clean, high quality fuels of the following specifications, as defined by ASTM designation D975 for diesel fuels:
 - a. Use grade no. 2 diesel at ambient temperatures above freezing 32°F (0°C).
 - b. Use grade no. 1 at ambient temperatures below freezing and for all temperatures at an altitude of above 5,500 ft. (1500 meters).
2. Use fuel having less than 1% sulphur (preferably less than 0.5%).
3. The cetane number should be a minimum of 45.
4. DO NOT use these unsuitable grades of fuel:
 - a. Domestic heating oils, all types.
 - b. Class B engine.
 - c. Class D domestic fuels.
 - d. Class E, F, G or H industrial or marine fuels.
 - e. ASTM-D975-60T No. 4-D and higher number fuels.
5. Biodiesel:

Biodiesel involves the transesterification of vegetable oils or animal fats. It can involve animal fats, yellow greases (used greases), cotton seed, sunflower seed, coconut oil, or sesame seed, but mainly in the US soybean methyl ester is used (SME). In Europe mainly rapeseed (canola) methyl ester is made (RME), and in Asia palm methyl ester (PME) is made. 100% biodiesel (B100) is made in compliance with ASTM D6751 or EN14214 (EU) specifications.

Biodiesel may be used in a 5% blend (5% biodiesel/ 95% diesel) from a BQ-9000 accredited producer. 20% biodiesel blends (20% biodiesel/ 80% diesel) can only be used if they meet ASTM D6751 or EN14214 (EU) specifications. A 2% reduction in power and a 3% reduction in fuel economy can be expected if a 20% blend is used. With a 20% biodiesel blend, an approved fuel conditioner is recommended. The petroleum part of the biodiesel blend must meet ASTM D975 or EN590 (EU) specifications. Biodiesel blends must be used within 90 days of their manufacture. When biodiesel blends are used the oil level must be checked daily and storage, leaking, possible microbial growth, plugging, and components degradation must all be checked more frequently.

Note: Using raw pressed or partially refined vegetable oils or recycled greases as fuel (which have not been through transesterification) could cause engine failure.

Request a certificate of analysis from an approved biodiesel fuel distributor to make sure the biodiesel blend meets specifications.

6. Storing fuel:
 - a. Keep dirt, scale, water, and other foreign matter out of fuel.
 - b. Avoid storing fuel for long periods of time.
 - c. Fill the fuel tank at the end of each day's operation. This will reduce condensation.

SP7-9. FUEL FILTERS

1. Your generator set should have a primary fuel filter installed. We recommend the Racor brand of fuel filter-water separators.
 - a. Check the primary fuel filter daily as recommended by the filter manufacturer. Empty the collection bowl as necessary.
 - b. Change the element as often as necessary or every 200 hours.
 - c. If the bowl fills with water, change the primary and secondary element immediately.
2. Change secondary fuel filter every 250 hours.
 - a. Remove the spin-on filter by turning it counterclockwise with a filter wrench. Fill the new cartridge with fuel and install it after applying engine oil to gasket surface. Screw on until the gasket surface comes into contact with sealing surface of filter base. Then, tighten it two-thirds of a turn by hand. Do not overtighten.
 - b. The fuel filter part number is:
773LW3 – #24-52020

Servicing

SP10. BLEEDING THE FUEL SYSTEM



CAUTION: Escaping diesel fuel under pressure can penetrate skin causing serious personal injury. Before disconnecting lines be sure to relieve all pressure. Before applying pressure, be sure all connections are tight and lines, pipes and hoses aren't damaged. Fuel escaping from a very small hole can be almost invisible. Use a piece of cardboard or wood, rather than hands, to search for suspected leaks. If injured by escaping fuel, see a doctor at once. Serious infection or reaction can develop if proper medical treatment isn't administered immediately.

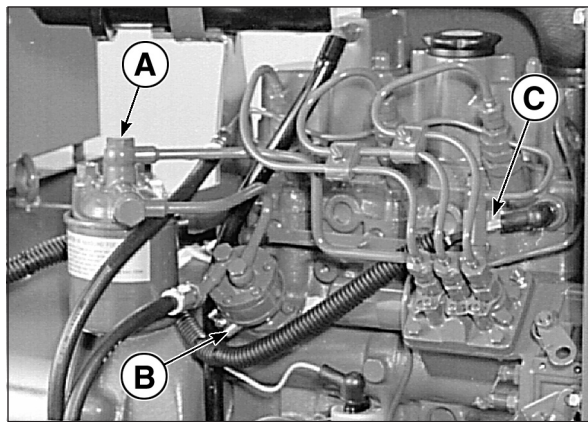

Figure 6: The Fuel System - the NL773LW4 varies slightly from this depiction

1. The fuel system is self-bleeding. However, any system may need manual bleeding when:
 - a. A new fuel filter is installed;
 - b. The engine has run out of fuel;
 - c. The fuel lines, injection pump or any other fuel system component has been removed and installed.
2. Loosen bleed bolt “A” (Figure 6) on top of the filter. Pump hand primer “B” on fuel lift pump until pure fuel (no bubbles) escapes from bleed bolt “A”. Tighten bleed screw “A”.
3. Loosen bleed screw “C”. Pump hand primer “B” until pure fuel (no bubbles) escapes. Then tighten bleed screw “C”.
4. If the engine does not start after the above bleeding process, loosen a fuel line at the injector while cranking the engine with the starter motor until pure fuel escapes. Then tighten the connection. Do each line **one-at-a-time**.
5. After the engine has started, use a piece of cardboard to look for fuel leaks.

Servicing

For illustration purposes only - the NL773LW4 may look a little different.

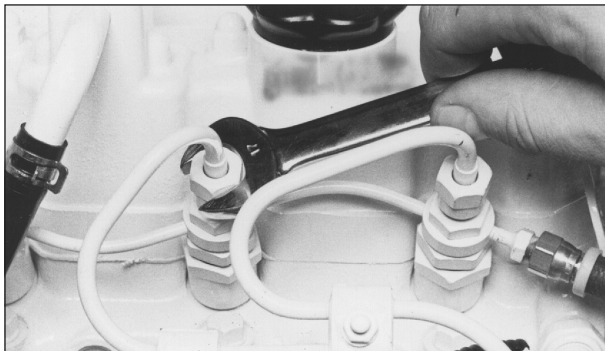

Figure 7: Remove delivery line flare nuts.

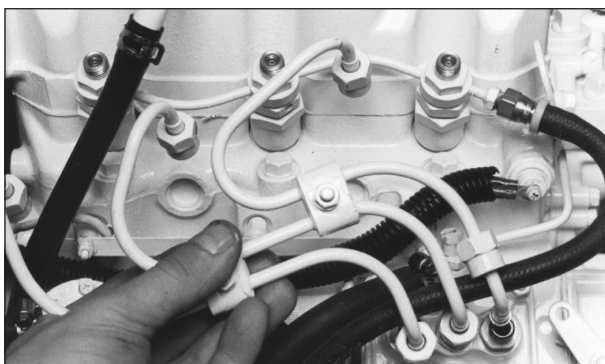

Figure 8: Remove delivery lines.

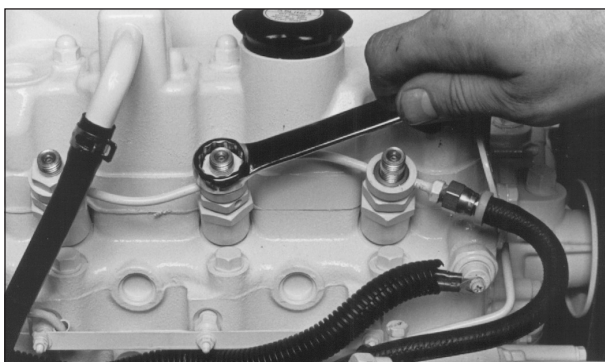

Figure 9: Remove return line nuts.

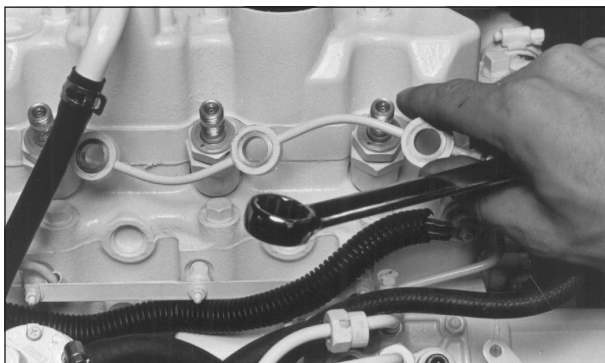

Figure 10: Remove return line.

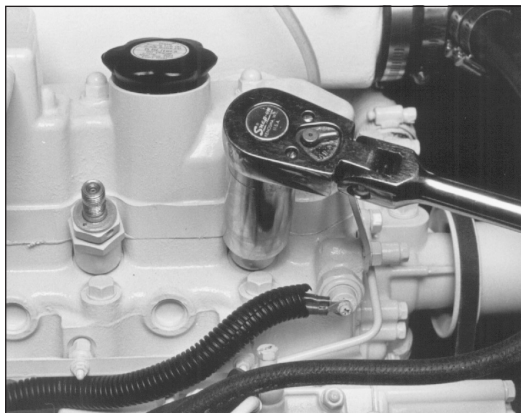

Figure 11: Unscrew injector.

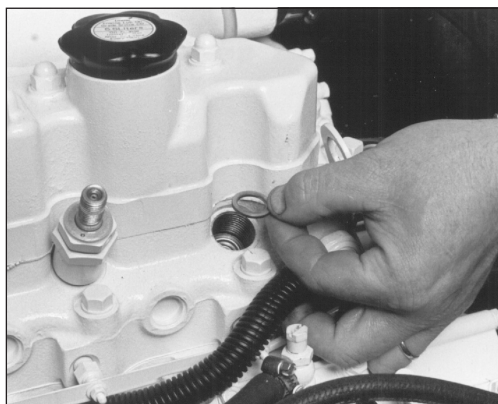

Figure 12: Remove and replace copper sealing washer.



Figure 13: Reinstall injector. Torque to proper tightness.

Servicing

SP11. INJECTOR SERVICE

1. Injectors should be checked every 1000 hours. Check should be made by a Northern Lights dealer or local injection repair station.



CAUTION: *Escaping diesel fuel under pressure can have sufficient force to penetrate the skin causing serious personal injury. If injured by escaping diesel fuel, see a doctor at once.*

2. Injector removal:

- a. Clean loose dirt from around the injectors and the fuel lines.
- b. Relieve high pressure in the fuel lines by loosening the delivery line flare nuts at each injector (Figure 8).
- c. Remove delivery lines by disconnecting from injectors and injection pump (Figure 9). Remove all lines as an assembly; do not remove the spacers. Cover the ends of the lines, the injector inlets and injection pump outlets to keep dirt out.
- d. Remove the return line retaining bolts (Figure 10). Remove the return line (Figure 11).
- e. Unscrew and remove the injectors (Figure 12).
NOTE: *Do not use pry bars to remove injectors from cylinder head.*
- f. After removing the injectors, discard the copper sealing washers from the injector hole in the head (Figure 13). Cover holes to prevent dirt and debris from entering the cylinders.

3. Injector installation:

- a. Install a new copper sealing washer in each injector hole (Figure 13).
- b. Screw in injector and tighten to 43 or 50 ft/lbs (6 to 7 kgm) (Figure 14).
NOTE: *Overtightening can damage injector.*
- c. Install return line using new copper sealing above and below each connection. Tighten return line retaining bolts to 22 - 30 ft/lbs.
- d. Install delivery lines. Leave loose at injectors for bleeding.
- e. Pump hand level on fuel pump to fill lines. Tighten lines at injectors. Start engine and check for leaks using a piece of paper or cardboard.
DO NOT use hand to check for leaks.

SP12. INJECTION PUMP

1. Since operating conditions may vary considerably, it is difficult to give a definite interval for checking the injection pump. But as a rule, pump settings, maximum speed, idle speed and exhaust smoke should be checked after every 2500 hours of operation. Service of the fuel injection pump should only be done if checks indicate pump malfunction.
2. Black smoke can be an indication of pump malfunction. Before servicing the pump, check other possible causes:
 - a. Check cleanliness of air filter.
 - b. Check valve clearances.
 - c. Clean and check injectors.
3. Any repair which involves disassembly of the injection pump must be carried out by specially trained mechanics with the proper tools and test equipment.

NOTE: *All warranties on the engine become null and void if the injection pump seals are broken by unauthorized persons.*

COOLING SYSTEM - GENERAL



CAUTION: *The cooling water in the engine reaches extremely high temperatures. You must use extreme caution when working on hot engines to avoid burns. Allow the engine to cool before working on the cooling system. Open the filler cap carefully, using protective clothing when the engine is warm.*

WATER QUALITY

1. Distilled, deionized, soft water is preferred for use in cooling systems. Bottled distilled water from a food store or water supplier is recommended. Tap water often has a high mineral content. Tap water should NEVER be put in a cooling system unless first tested by a water quality laboratory. Do not use water made by the reverse osmosis method unless it has been PH neutralized.

Servicing

2. Here are acceptable water quality specifications:

Contaminates	Parts per Million	Grains per Gallon
Maximum Chlorides	40	2.5
Maximum Sulfates	100	5.9
Maximum Dissolved Solids	340	20.0
Maximum Total Hardness	170	10.0
PH Level 5.5 to 9.0		

- If chlorides, sulfates or total dissolved solids are higher than the above given specification, the water must be distilled, demineralized, or deionized before it is used in a cooling system.
- If total hardness is higher than 170 ppm and all other parameters are within the given specifications, the water must be softened before it is used to make coolant solution.

SP13. CHECK THE COOLANT LEVEL

- Check the coolant level each day before starting the engine. Check the water level by removing the pressure cap from the radiator.
In order to give the cooling water an opportunity to expand, the level should be about 1 in. (2.5 cm) below the filler cap sealing surface when the engine is cold.
- The pressure valve in the filler cap releases when the pressure is approximately 7 PSI (0.5 bar). Use a cap pressure tester to check cap if you suspect it is faulty.

SP14. COOLING SYSTEM FLUSHING

- Flush the cooling system every 2500 hours or every 12 months, whichever comes first.
- Industrial sets:
Remove radiator cap and open drain cocks on radiator and engine block. Pour clean water into radiator until water coming from radiator is clear of discoloration. Close the radiator drain and continue flushing until water from engine drain is clear. Open all drain cocks and drain completely. Close drain cock and refill with recommended coolant mixture. Clean fins on radiator.
- Coolant Specifications:
Use 50% water / 50% ethylene glycol antifreeze mix. Antifreeze mixture is recommended as a good year-round coolant.
- Check hoses and connections and repair any leakage.

SP16. CLEAN RADIATOR

- Remove debris from radiator fins daily.
- In very dusty applications, clean the radiator with compressed air or steam cleaner every 100 hours.
Clean in the reverse direction of the airflow.

ELECTRICAL SYSTEM - GENERAL

- Never switch battery switch off or break the circuit between the alternator and batteries while the engine is running. Regulator damage can result.
- Do NOT reverse the polarity of battery cables when installing the battery.
- When welding on the unit, disconnect the regulator and battery. Isolate the leads.
- Disconnect the battery cables when servicing the D.C. alternator.
- Never test with a screwdriver, etc., against any terminal to see if it emits sparks.
- Do not polarize the alternator or regulator.
- A D.C. circuit breaker protects your control panel and wiring harness. It is located in the side of the generator junction box.

Servicing

GLOW PLUGS

1. Each cylinder is supplied with a glow plug which serves to heat the combustion chamber.
2. To check the glow plugs, loosen the current carrying flat wire between the plus-poles of the glow plugs (Figure 14). Connect a D.C. test bulb between the plus-pole of the battery and the plus-pole of the glow plug. If the bulb lights up, the glow plug is functioning properly.
3. Check all glow plugs and replace any faulty ones.

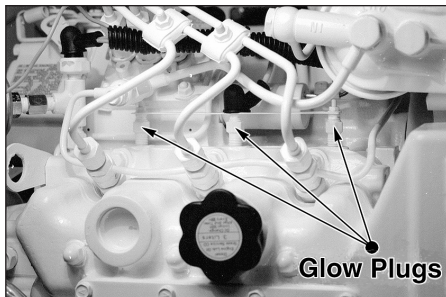

Figure 14: Glow plugs.

BOOSTER BATTERIES



CAUTION: Battery gas can explode.
Keep all flames and sparks away from batteries.

1. Before changing or using booster batteries, check battery electrolyte level. Add distilled water if necessary.
2. Booster and main batteries must have the same voltage rating.
3. First, connect positive (+) terminal of booster battery to positive (+) terminal of main battery. Then, connect negative (-) terminal of booster battery to ground on the engine block (see Figure 15).
4. Remove booster battery after starting engine.
5. Sealed batteries: See manufacturer charging and booster instructions.

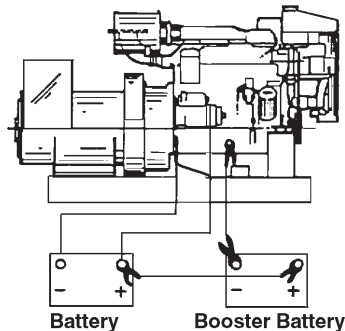

Figure 15:
Battery connections.

SP 18-19. BATTERY CARE

1. Check electrolyte level every 50 hours or once per month. Add distilled water to manufacturer's recommended level.
2. Batteries, cables and cable terminals should be checked and cleaned every 100 hours. Clean corrosion with a water and baking soda solution. Flush with clean water. Tighten terminals and grease them to inhibit corrosion.
3. Check the battery condition with a hydrometer every 250 hours.

SP20. WINTERIZING / OUT-OF-SERVICE

1. Industrial sets:
 - a. Drain and flush the radiator and cooling system. Leave dry or refill with antifreeze-water mixture. If refilling, start the engine and run to circulate the antifreeze.
 - b. Fill the fuel tank or add biocide as per manufacturer's instructions.
 - c. Seal the air cleaner inlet, exhaust opening, crankcase breather pipe, and fuel tank vent with plastic bags and tape.
 - d. Store the set in a dry, protected place. If unit must be stored outside, be sure it is well protected with a cover.
 - e. Change the crankcase oil and filter.
 - f. Loosen the alternator belt.
 - g. Disconnect and clean battery. Remove to warm storage place if possible.
 - h. Clean outside of unit. Paint any scratched or chipped surfaces. Put corrosion preventative on all exposed metal surfaces.

Troubleshooting

DC ELECTRICAL SYSTEM

PROBLEM	POSSIBLE CAUSE	RECOMMENDATION(S)
Battery Will Not Charge	Loose or corroded connections	• Clean and tighten battery connections.
	Sulfated or worn out batteries	• Check specific gravity of each battery. • Check electrolyte level of each battery.
	Loose or defective alternator belt	• Adjust belt tension. • Replace belt.
Starter Inoperative	Check DC circuit breaker	• If the breaker is tripped, reset it.
	Loose or corroded connections	• Clean and tighten loose battery and harness plug connection.
	Low battery output	• Check specific gravity of each battery. • Check electrolyte level of each battery.
	Defective electrical system ground wire:	• Repair or replace.
Starter Cranks Slowly	Low battery output	• Battery is too small. • Battery cables are too small.
	Check specific gravity of each battery	• Replace battery if necessary.
	Check electrolyte level of each battery	• If low, fill cells with distilled water.
	Crankcase oil too heavy	• Fill with oil of appropriate viscosity.
	Loose or corroded connections	• Clean and tighten loose connections.
Entire Electrical System Does Not Function	Check DC circuit breaker	• If breaker is tripped, reset it.
	Faulty connection	• Clean and tighten battery and harness plug connections.
	Sulfated or worn out batteries	• Check specific gravity and electrolyte level of each battery.

If you cannot correct problems with these procedures, see your **Northern Lights** dealer.

Troubleshooting

Lamp Flashing Pattern when Error has Occurred

Before starting the engine:

1. Check all connections before powering the Engine ECU on.
2. When the Engine ECU is powered on (assuming no failures), the lamp will flash one time and then off.
3. If an Engine ECU failure is detected, the lamp will flash one of the codes below.
4. To resolve an Engine ECU failure, turn power off, check and connect wiring connections and power on again.

Figure 16: Lamp Codes

Lamp Code	Reason For Error	Error Detection	After Error Detection
13	Oil pressure SW failure or wire disconnected	Engine ECU Power ON (EG Start Enable)	Go to Low Power Mode
22	Pressure Sensor failure or wire disconnected	Engine ECU Power ON (EG Start Enable)	Go to Low Power Mode
33	Pressure Sensor failure or wire disconnected	Engine running	Go to Low Power Mode
15	Speed Sensor Failure or wire disconnected	Engine ECU Power ON (EG Start Enable)	Go to Low Power Mode
04	Actuator drive wire disconnected	Engine running	Engine doesn't start
		Engine ECU Power ON	Go to Low Power Mode
		Cranking	Lamp action only
			Engine doesn't start

Lamp Code Analysis

Lamp Code specifies the pattern of long and short flashes the ECU uses to indicate a particular problem. The lamp will continue flashing as shown below until the error is resolved.

Case 1. Error Only:

Code: 13: Long, Short, Short, Short

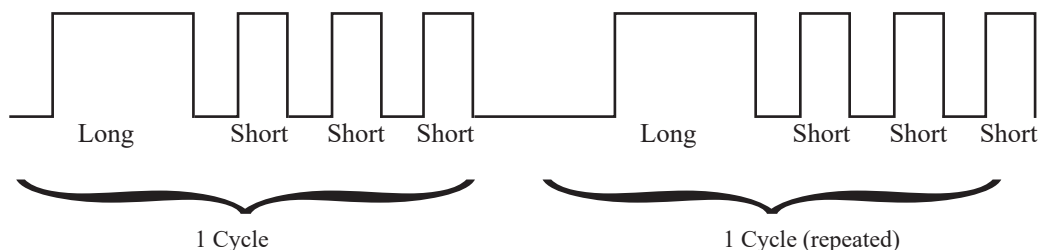

Case 2. Error combination (when 2 errors occur at the same time):

Code 13: 13 means Long, Short, Short, Short

Code 04: 04 means Short, Short, Short, Short

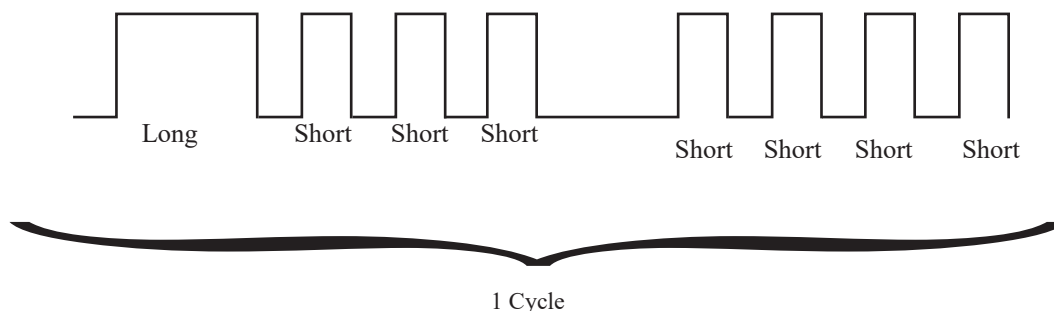

Troubleshooting

ENGINE

PROBLEM	POSSIBLE CAUSE	RECOMMENDATION(S)
Engine Hard to Start or Will Not Start	Improper starting procedure	<ul style="list-style-type: none"> • See starting section of this manual. Take special note of Bypass Switch operation.
	No fuel	<ul style="list-style-type: none"> • Check level of fuel in fuel tank.
	Low battery output	<ul style="list-style-type: none"> • Check electrolyte level and condition.
	Excessive resistance in starting circuit	<ul style="list-style-type: none"> • Clean and tighten all battery connections.
	Crankcase oil too heavy	<ul style="list-style-type: none"> • Use oil of proper viscosity.
	Improper type of fuel	<ul style="list-style-type: none"> • Consult fuel supplier and use proper type of fuel for operating condition.
	Water, dirt or air in fuel system	<ul style="list-style-type: none"> • Drain, flush, fill and bleed system.
	Clogged primary fuel filter element	<ul style="list-style-type: none"> • Clean or replace filter element.
	Lift pump malfunction	<ul style="list-style-type: none"> • Repair lift pump.
	Clogged secondary fuel filter element	<ul style="list-style-type: none"> • Replace filter element.
Engine Runs Irregularly or Stalls Frequently	Dirty or faulty injection nozzles	<ul style="list-style-type: none"> • Have your dealer check injection nozzles.
	Uneven compression pressure between cylinders.	<ul style="list-style-type: none"> • Check cylinder compression pressure.
	Below normal engine temperature	<ul style="list-style-type: none"> • Remove and check thermostat.
	Clogged primary fuel filter element	<ul style="list-style-type: none"> • Clean or replace filter element.
	Clogged secondary fuel filter element	<ul style="list-style-type: none"> • Replace secondary filter element.
	Water or dirt in the fuel system	<ul style="list-style-type: none"> • Drain, flush, fill and bleed system.
	Dirty or faulty injection nozzles	<ul style="list-style-type: none"> • Have your dealer check injection nozzles.
Lack of Engine Power	Air in fuel system	<ul style="list-style-type: none"> • Inspect clamps and hoses on suction side of fuel pump for air leak.
	Improper type of fuel	<ul style="list-style-type: none"> • Consult fuel supplier and use proper type of fuel for operating condition.
	Intake air restriction	<ul style="list-style-type: none"> • Service air cleaner, check proper ventilation.
Lack of Engine Power	Clogged primary fuel filter element	<ul style="list-style-type: none"> • Clean or replace filter element.
	Clogged secondary fuel filter element	<ul style="list-style-type: none"> • Replace filter element.
	Injection pump not getting fuel	<ul style="list-style-type: none"> • Have injection pump checked.
	Improper type of fuel	<ul style="list-style-type: none"> • Consult fuel supplier and use proper type of fuel for operating conditions.

Troubleshooting

ENGINE

PROBLEM	POSSIBLE CAUSE	RECOMMENDATION(S)
Lack of Engine Power <i>(continued)</i>	Improper type of fuel	<ul style="list-style-type: none"> • Consult fuel supplier and use proper type of fuel for operating conditions.
	Overheated engine	<ul style="list-style-type: none"> • See “Engine Overheats” in next category.
	Below normal engine temperature	<ul style="list-style-type: none"> • Remove and check thermostat.
	Improper valve clearance	<ul style="list-style-type: none"> • Reset valves. Best done by dealer.
	Dirty or faulty injection nozzles	<ul style="list-style-type: none"> • Replace injectors. Best done by dealer. • See your local dealer.
	Poor cylinder compression pressure	<ul style="list-style-type: none"> • Check bore for wear, or check alignment of nozzle holder. Re-adjust valve clearance.
Engine Overheats	Low coolant level	<ul style="list-style-type: none"> • Fill tank or radiator to proper level, with proper mixture of coolant. • Check hoses for loose connections and leaks.
	Air cleaner element clogged	<ul style="list-style-type: none"> • Clean or replace.
	Cooling system interior dirty	<ul style="list-style-type: none"> • Flush cooling system.
	Defective thermostat	<ul style="list-style-type: none"> • Remove and check thermostat.
	Defective temperature gauge	<ul style="list-style-type: none"> • Check water temperature with thermometer and replace gauge if necessary.
	Water pump impeller worn/broken	<ul style="list-style-type: none"> • Check impeller and replace if necessary.
	V belts slipping	<ul style="list-style-type: none"> • Fix belts to proper tension.
Engine Knocks	Insufficient oil	<ul style="list-style-type: none"> • Call your dealer.
	Injection pump timing off	<ul style="list-style-type: none"> • Call your dealer.
	Below normal engine temperature	<ul style="list-style-type: none"> • Check your thermostats. • Check water temperature to see if temperature gauge is working properly.
	Engine overheating	<ul style="list-style-type: none"> • See “Engine Overheating” section.
High Fuel Consumption	Improper type of fuel	<ul style="list-style-type: none"> • Use correct fuel for temperature.
	Clogged or dirty air cleaner	<ul style="list-style-type: none"> • Service air cleaner.
	Improper valve clearance	<ul style="list-style-type: none"> • See your dealer.
	Injection nozzles dirty	<ul style="list-style-type: none"> • See your dealer.
	Injection pump timing off	<ul style="list-style-type: none"> • See your dealer.
	Engine not at proper temperature	<ul style="list-style-type: none"> • Check your thermostats. • Check water temperature with thermometer and replace gauge if necessary.

If you cannot correct problems with these procedures, see your **Northern Lights** dealer.

Troubleshooting

ENGINE

PROBLEM	POSSIBLE CAUSE	RECOMMENDATION(S)
High Fuel Consumption <i>(continued)</i>	Fuel leakage	• Improper installation or tightening.
	Excessive load on engine	• Check loads.
Below Normal Engine Temperature	Thermostat not working properly	• Check thermostat.
	Temperature gauge not working properly	• Check water temperature with thermometer.
Engine Malfunctions at High Output Range	Fuel supply insufficient	• Air in fuel system or clogged fuel filter element
	Fuel injection amount between plungers uneven	• Check fuel injectors
	Valve clearance adjusted incorrectly	• Re-adjust valve clearances
	Valve spring broken	• Replace valve spring
	Governor spring broken	• Replace governor spring
Low Oil Pressure	Low oil level	• Fill crankcase to proper level.
	Improper type of oil	• Drain and fill crankcase with correct oil.
	Partially plugged oil filter	• Replace filter. Check bearings, oil pump, and relief valve for wear.
High Oil Consumption	Break-in period	• Oil consumption decreases after break in.
	Crankcase oil too light	• Use proper viscosity oil.
	Oil leaks	• Check for leaks in lines around gaskets and drain plug.
Engine Emits Black or Gray Exhaust Smoke	Clogged or dirty air cleaner	• Service air cleaner.
	Defective muffler (back pressure too high)	• Have dealer check back pressure.
	Improper fuel	• Use correct fuel for temperature.
	Injection nozzles dirty	• See your dealer.
	Engine injectors timing off	• See your dealer.
Engine Emits White Smoke	Improper fuel	• Use correct fuel for temperature.
	Cold engine	• Warm up engine to normal operating temperature.
	Defective thermostat	• Remove and check thermostat.
	Engine injectors timing off	• See your dealer.

If you cannot correct problems with these procedures, see your **Northern Lights** dealer.

AC Wiring Diagrams

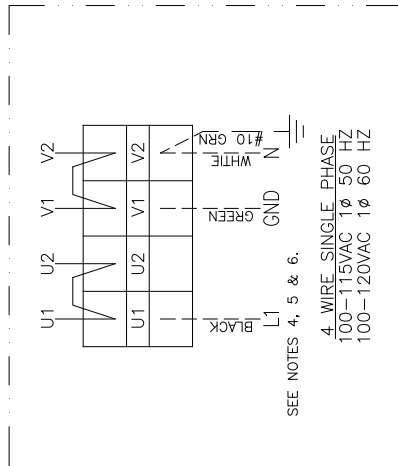
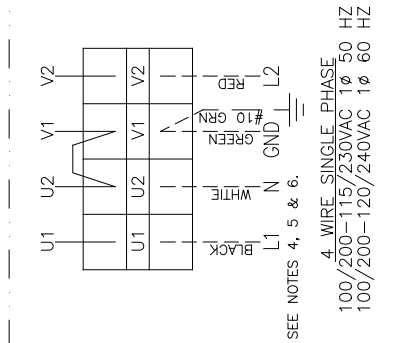
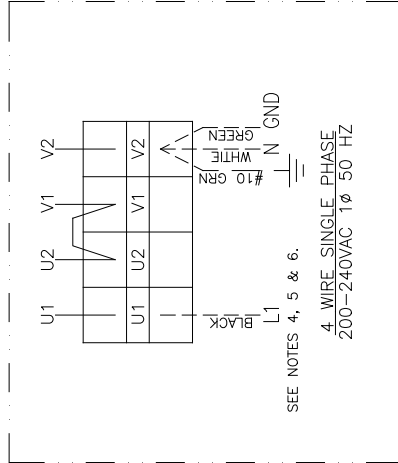

HEATER SPEC	VOLTAGE	500W CURRENT	750W CURRENT	1000W CURRENT	1500W CURRENT
120 VAC	100-120 VAC	5 A	7 A	10 A	13 A
240 VAC	200-240 VAC	3 A	4 A	5 A	7 A

OPTIONAL BLOCK HEATERS

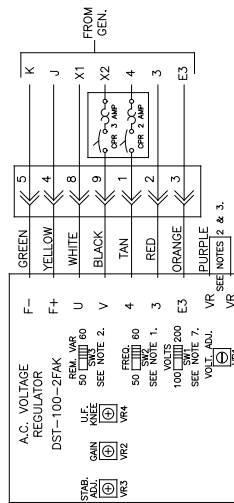
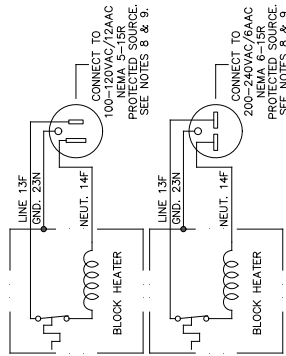

NOTES:

1. SET SW2 FOR CURRENT APPLICATION, (50 OR 60 HZ.)
2. SET SW3 PER APPLICATION IF REMOTE VOLTAGE ADJUST RHEOSTAT IS USED.
3. FOR REMOTE VOLTAGE ADJUST RHEOSTAT CUT JUMPER AND SPLICE INTO PURPLE LEADS.
4. TERMINAL BLOCKS WILL NOT ACCOMMODATE LARGER GAUGE CONDUCTORS. IF REQUIRED, REMOVE AFFECTED LEADS FROM TERMINAL BLOCK(S) AND MAKE CONNECTIONS USING BOLT, LOCK WASHER AND NUT. ISOLATE BY WRAPPING WITH ELECTRICAL TAPE.
5. MARINE GENSETS ARE GROUNDING BY CUSTOMER, AT CUSTOMER'S DISCRETION. INDUSTRIAL GENSETS ARE TO BE GROUNDING IN ACCORDANCE WITH THE NATIONAL ELECTRICAL CODE AND ANY APPLICABLE LOCAL CODES. HIDDEN (DASHED) LINES INDICATE CUSTOMER SUPPLIED AND CONNECTED MAIN OUTPUT CONDUCTORS. SIZING TO BE DETERMINED PER LOCAL CODES.
6. AVR INPUT SENSING SWITCH SW1 IS TO BE SET TO THE 200V POSITION FOR ALL VOLTAGES EXCEPT 100-120VAC APPLICATIONS.
7. DO NOT ENERGIZE HEATER WHEN UNIT IS IN OPERATION.
8. REMOVE THREE-POLE PLUG AND WIRE BLOCK HEATER LEADS TO TERMINALS NUMBERED AS INDICATED FOR MARINE DUTY UNITS ONLY.

AC Engine Wiring Diagram AC 4W NL773LW4 Drawing #B-9724J

Wiring diagrams are subject to change without notice.

AC Wiring Diagrams

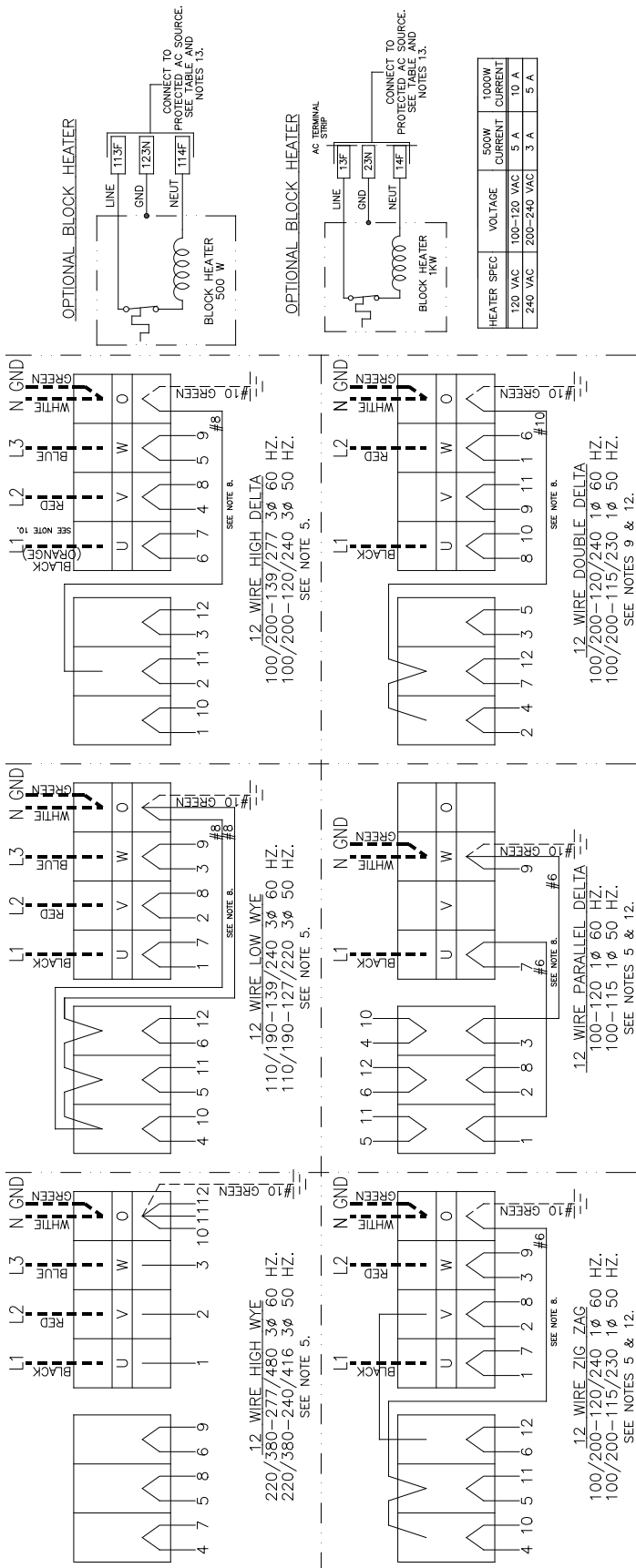

NOTES:

1. ALL NLI INSTALLED CONDUCTORS ARE TO BE TYPE MTW, 105°C, STRANDED, 600VAC.
2. SET SW2 FOR CURRENT APPLICATION, (50 OR 60 HZ).
3. FOR REMOTE VOLTAGE ADJUST PRESTAT, CIRCUIT BREAKER AND SPURGE INT. PURPLE LEADS.
4. DELETE NEUTRAL CONDUCTOR (AND JUMPER IF PRESENT), IF LOWER VOLTAGE IS NOT REQUIRED.
5. MARINE GENSETS ARE GROUNDED BY CUSTOMER, AT CUSTOMER'S DISCRETION, INDUSTRIAL GENSETS ARE TO BE GROUNDED IN ACCORDANCE WITH THE NATIONAL ELECTRICAL CODE AND ANY APPLICABLE LOCAL CODES.
6. THICK HIDDEN (DASHED) LINES INDICATE CUSTOMER SUPPLIED AND CONNECTED MAIN OUTPUT CONDUCTORS.
7. THICK HIDDEN (DASHED) LINES INDICATE CUSTOMER SUPPLIED AND CONNECTED MAIN OUTPUT CONDUCTORS.
8. NEUTRAL CONDUCTORS SIZED FOR 30KW UNITS AT THE LOWEST LISTED VOLTAGE. CONSULT N.L.I. ENGINEERING FOR SIZING INFORMATION.
9. THE DOUBLE DELTA CONFIGURATION REQUIRES THE AVR TO BE REWIRING AS FOLLOWS: DISCONNECT LEADS 3 AND 4 FROM AVR. CONNECT LEAD 3 TO AVR TERM. 4 (THROUGH C.B.), CONNECT LEAD 4 TO AVR TERM. 3. DISCONNECT LEAD E3 FROM AVR AND ISOLATE. CONNECT AVR TERMINAL E3 TO MAIN OUTPUT BLOCK TERM. "W", USING A RED AWG 14 LEAD.
10. LINE ONE (HIGH LEG) TO BE MARKED ORANGE WHEN NEUTRAL IS PRESENT, IN ACCORDANCE WITH ARTICLE 215-8 OF THE NATIONAL ELECTRIC CODE.
11. AVR INPUT WIRING: SENSING SWITCH SW1 IS TO BE SET TO THE 200V POSITION FOR ALL VOLTAGES EXCEPT 120VAC.
12. THE 1Ø WIRING OPTIONS ARE FOR 16 KW THRU 30 KW MODELS ONLY.
13. DO NOT ENERGIZE HEATER WHEN UNIT IS IN OPERATION.

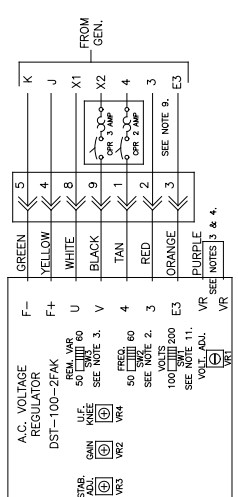

AC Engine Wiring Diagram
AC 12W NL773LW4
Drawing #B-9723H

Wiring diagrams are subject to change without notice.

DC Wiring Diagrams

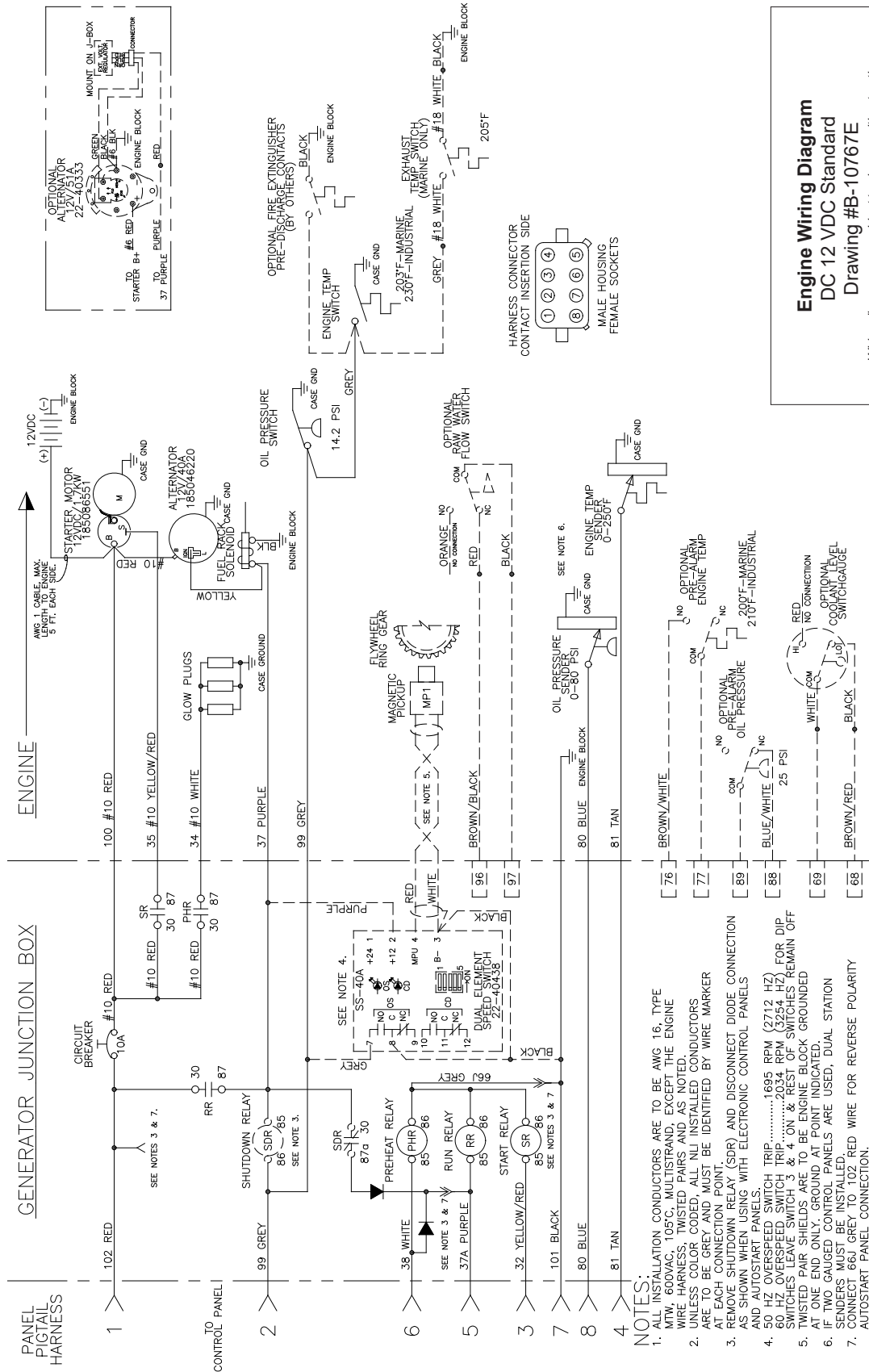

Engine Wiring Diagram
DC 12 VDC Standard
Drawing #B-10767E
Wiring diagrams are subject to change without notice.

DC Wiring Diagrams

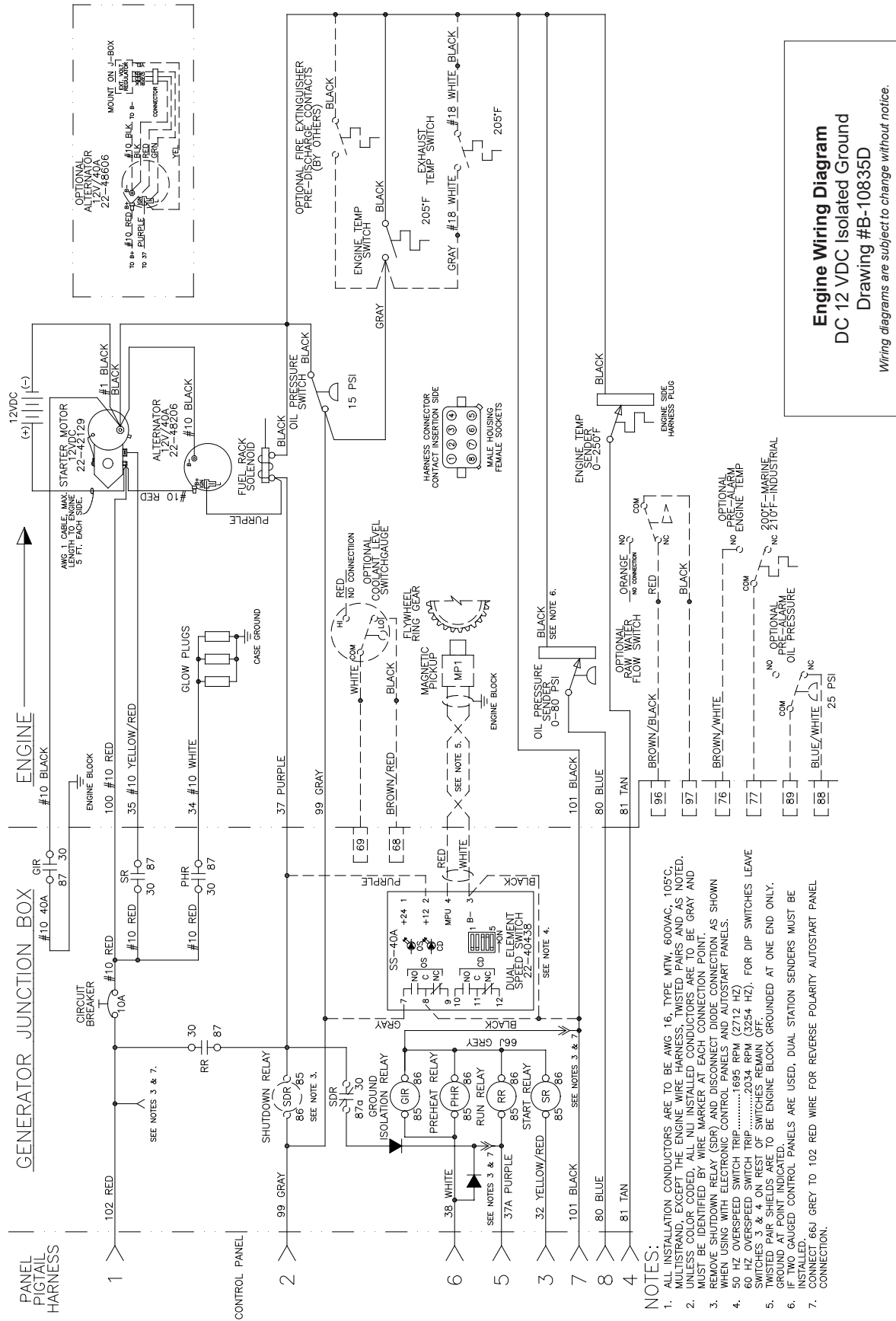

Engine Wiring Diagram
 DC 12 VDC Isolated Ground
 Drawing #B-10835D
 Wiring diagrams are subject to change without notice.

- NOTES:**
1. ALL INSTALLATION CONDUCTORS ARE TO BE AWG 16, TYPE MTW, 600VAC, 105°C, MULTISTRAND, EXCEPT THE ENGINE WIRE HARNESS, TWISTED PAIRS AND AS NOTED, UNLESS COLOR CODED. ALL NLI INSTALLED CONDUCTORS ARE TO BE GRAY AND MUST BE IDENTIFIED BY WIRE MARKER AT EACH CONNECTION POINT.
 2. REMOVE SHUTDOWN RELAY (SDR) AND DISCONNECT DIODE CONNECTION AS SHOWN WHEN USING WITH ELECTRONIC CONTROL PANELS AND AUTOSTART PANELS.
 3. 50 HZ OVERSPEED SWITCH TRIP:1695 RPM (2712 HZ)
 4. 60 HZ OVERSPEED SWITCH TRIP:2034 RPM (3354 HZ). FOR DIP SWITCHES LEAVE SWITCHES 3 & 4 ON REST OF SWITCHES REMAIN OFF.
 5. TWISTED PAIR SHIELDS ARE TO BE ENGINE BLOCK GROUNDED AT ONE END ONLY.
 6. NO AUGMENTED CONTROL PANELS ARE USED. DUAL STATION SENDERS MUST BE INSTALLED.
 7. CONNECT .66J GREY TO 102 RED WIRE FOR REVERSE POLARITY AUTOSTART PANEL CONNECTION.

DC Wiring Diagrams

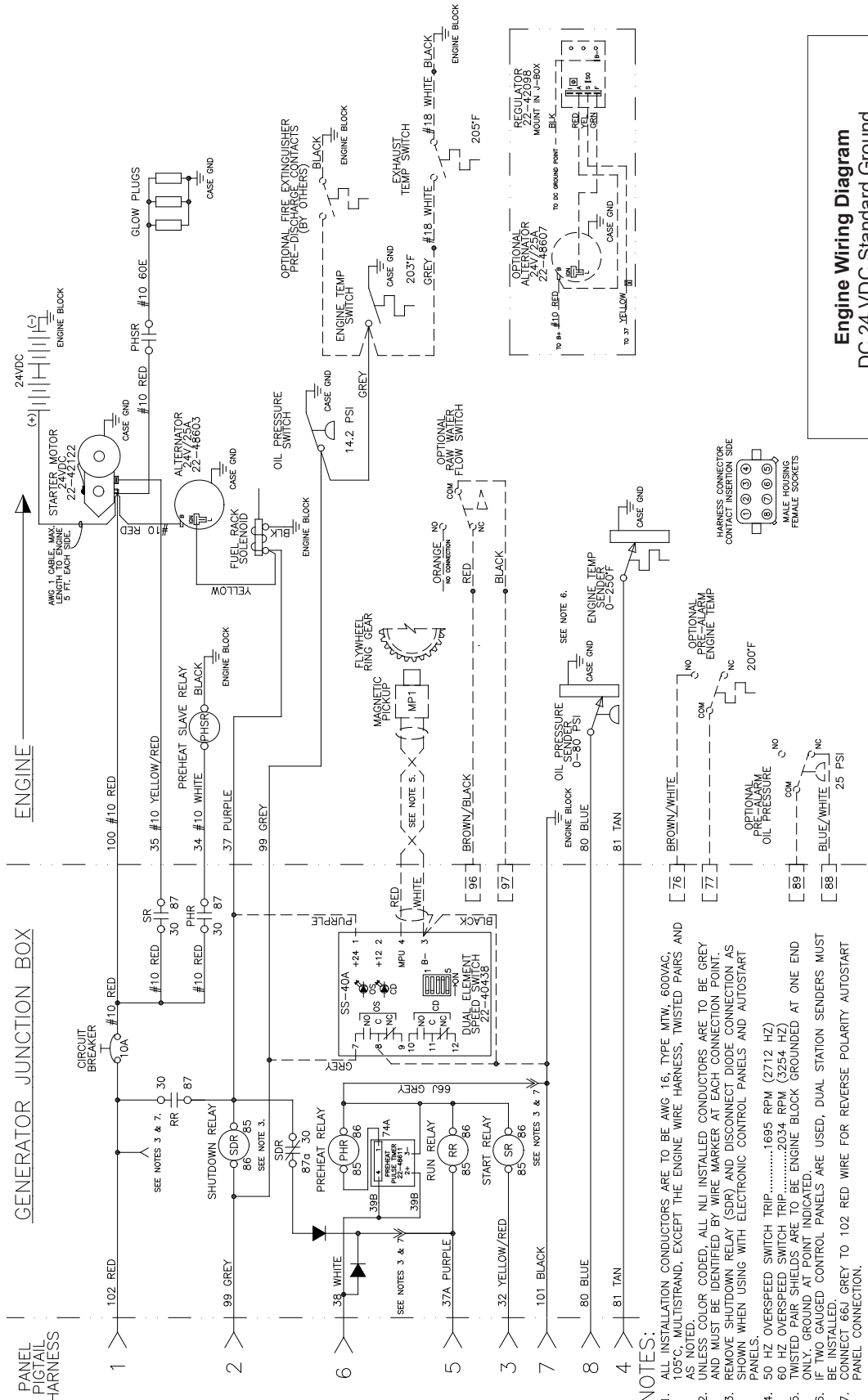

Engine Wiring Diagram
DC 24 VDC Standard Ground
Drawing #B-10834C
Wiring diagrams are subject to change without notice.

- NOTES:**
- ALL INSTALLATION CONDUCTORS ARE TO BE AWG 16, TYPE MTW, 600VAC, 105 C, MULTISTRAND, EXCEPT THE ENGINE WIRE HARNESS, TWISTED PAIRS AND UNLESS OTHERWISE SPECIFIED.
 - ALL CONDUCTORS SHOULD BE COLOR CODED. ALL WIRE HARNESS CONDUCTORS ARE TO BE GREY UNLESS OTHERWISE SPECIFIED. ALL WIRE HARNESS CONDUCTORS ARE TO BE IDENTIFIED BY WIRE MARKER AT EACH CONNECTION POINT.
 - REMOVE SHUTDOWN RELAY (SDR) AND DISCONNECT DIODE CONNECTION AS SHOWN WHEN USING WITH ELECTRONIC CONTROL PANELS AND AUTOSTART PANELS.
 - 50 HZ OVERSPEED SWITCH TRIP1695 RPM (2712 HZ)
 60 HZ OVERSPEED SWITCH TRIP2034 RPM (3254 HZ)
 - DUAL STATION SENDERS MUST BE USED. SENDERS MUST BE ENGINE BLOCK GROUNDING AT ONE END ONLY. GROUNDING AT POINT INDICATED.
 - IF TWO GAUGED CONTROL PANELS ARE USED, DUAL STATION SENDERS MUST BE INSTALLED.
 - CONNECT 66J GREY TO 102 RED WIRE FOR REVERSE POLARITY AUTOSTART PANEL CONNECTION.

DC Wiring Diagrams

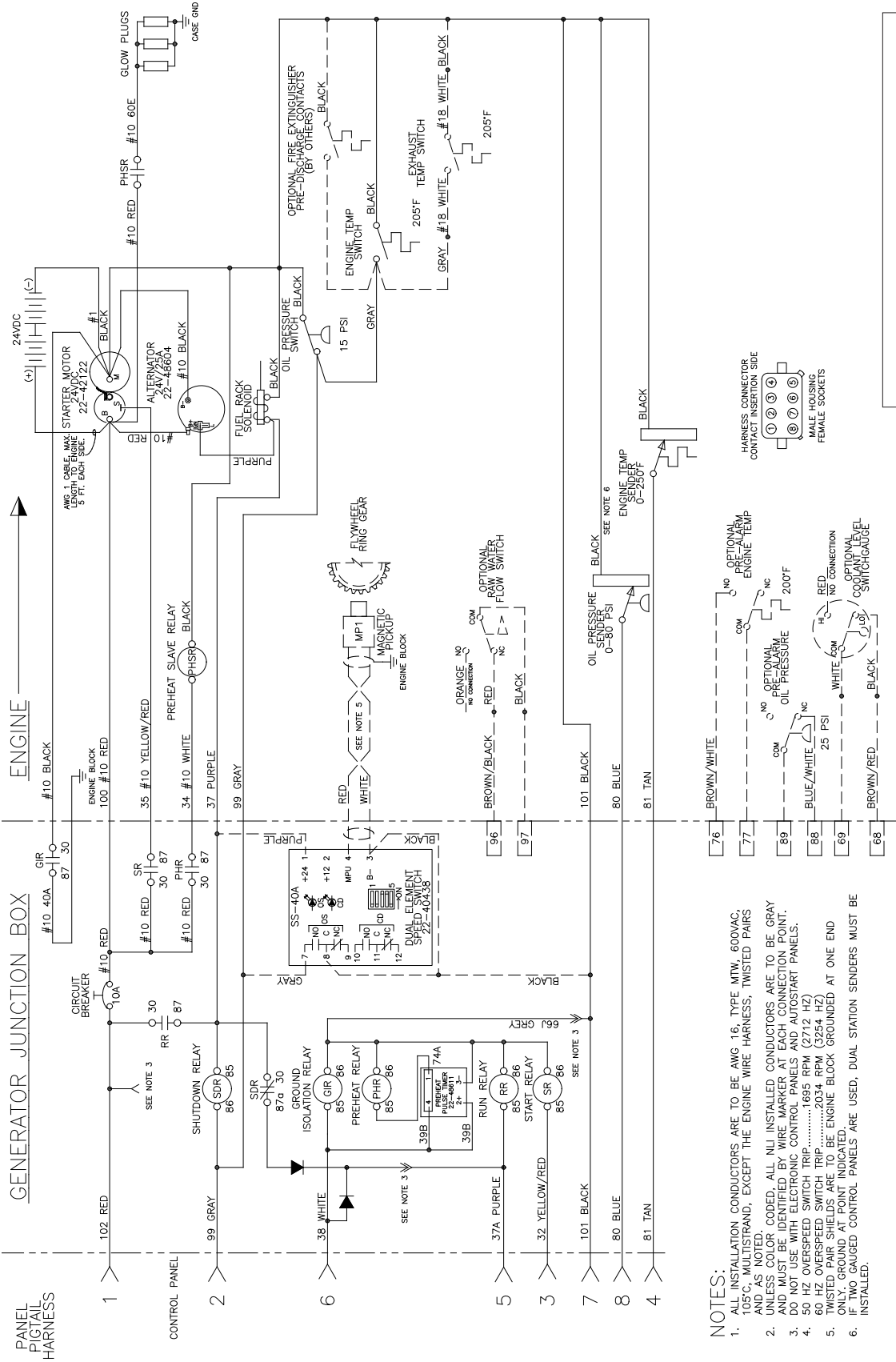

Engine Wiring Diagram
 DC 24 VDC Isolated Ground
 Drawing #B-10880C
Wiring diagrams are subject to change without notice.

- NOTES:**
1. ALL INSTALLATION CONDUCTORS ARE TO BE AWG 16, TYPE MTW, 600VAC 105°C, MULTISTRAND, EXCEPT THE ENGINE WIRE HARNESS, TWISTED PAIRS AND AS NOTED.
 2. UNLESS COLOR CODED, ALL NLI INSTALLED CONDUCTORS ARE TO BE GRAY AND MUST BE IDENTIFIED BY WIRE MARKER AT EACH CONNECTION POINT.
 3. DO NOT USE WITH ELECTRONIC CONTROL PANELS AND AUTOSTART PANELS.
 4. 50 HZ OVERSPEED SWITCH TRIP.....1695 RPM (2712 HZ)
 5. 60 HZ OVERSPEED SWITCH TRIP.....2034 RPM (3254 HZ)
 6. TWISTED PAIR SHIELDS ARE TO BE ENGINE BLOCK GROUNDED AT ONE END ONLY, GROUND AT POINT INDICATED.
 7. IF TWO GAUGED CONTROL PANELS ARE USED, DUAL STATION SENDERS MUST BE INSTALLED.

DC Wiring Diagram

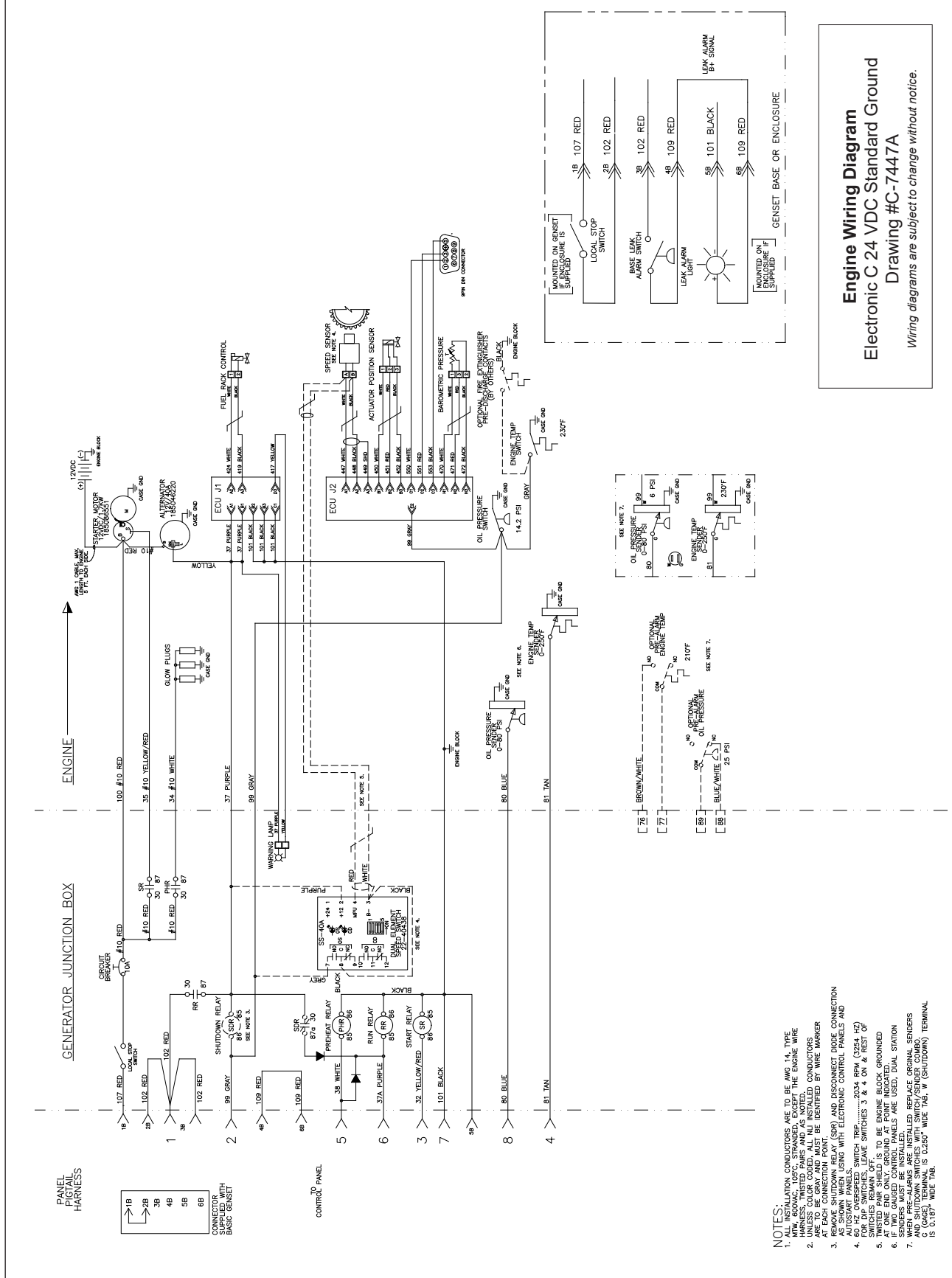

Engine Wiring Diagram
Electronic C 24 VDC Standard Ground
Drawing #C-7447A
Wiring diagrams are subject to change without notice.

- NOTES:**
1. ALL INSTALLATION CONDUCTORS ARE TO BE AWG 14, TYPE THHN, UNLESS NOTED OTHERWISE. THE ENGINE WIRE HARNESS, TWISTED PAIRS AND AS NOTED, UNLESS COLOR CODED, MUST HAVE INSTALLED CONDUCTORS AT EACH CONNECTION POINT.
 2. REMOVE SHUTDOWN RELAY (SR) AND DISCONNECT DIODE CONNECTION AUTOSTART PANELS.
 3. EACH TOP SWITCHED SWITCH (SR) MUST BE INSTALLED ON A RESISTOR REMAIN OFF.
 4. IF TWO GAUGED CONTROL PANELS ARE USED, DUAL STATION AT ONE END ONLY, GROUND AT POINT INDICATED.
 5. WHEN PRE-ALARMS ARE INSTALLED REPLACE ORIGINAL SENDERS AND SHUTDOWN SWITCHES WITH SWITCH/SENDER COMBO. SWITCH IS 0.250" WIDE 1/4" W (SHUTDOWN) TERMINAL IS 0.187" WIDE 1/4" W.

DC Wiring Diagrams

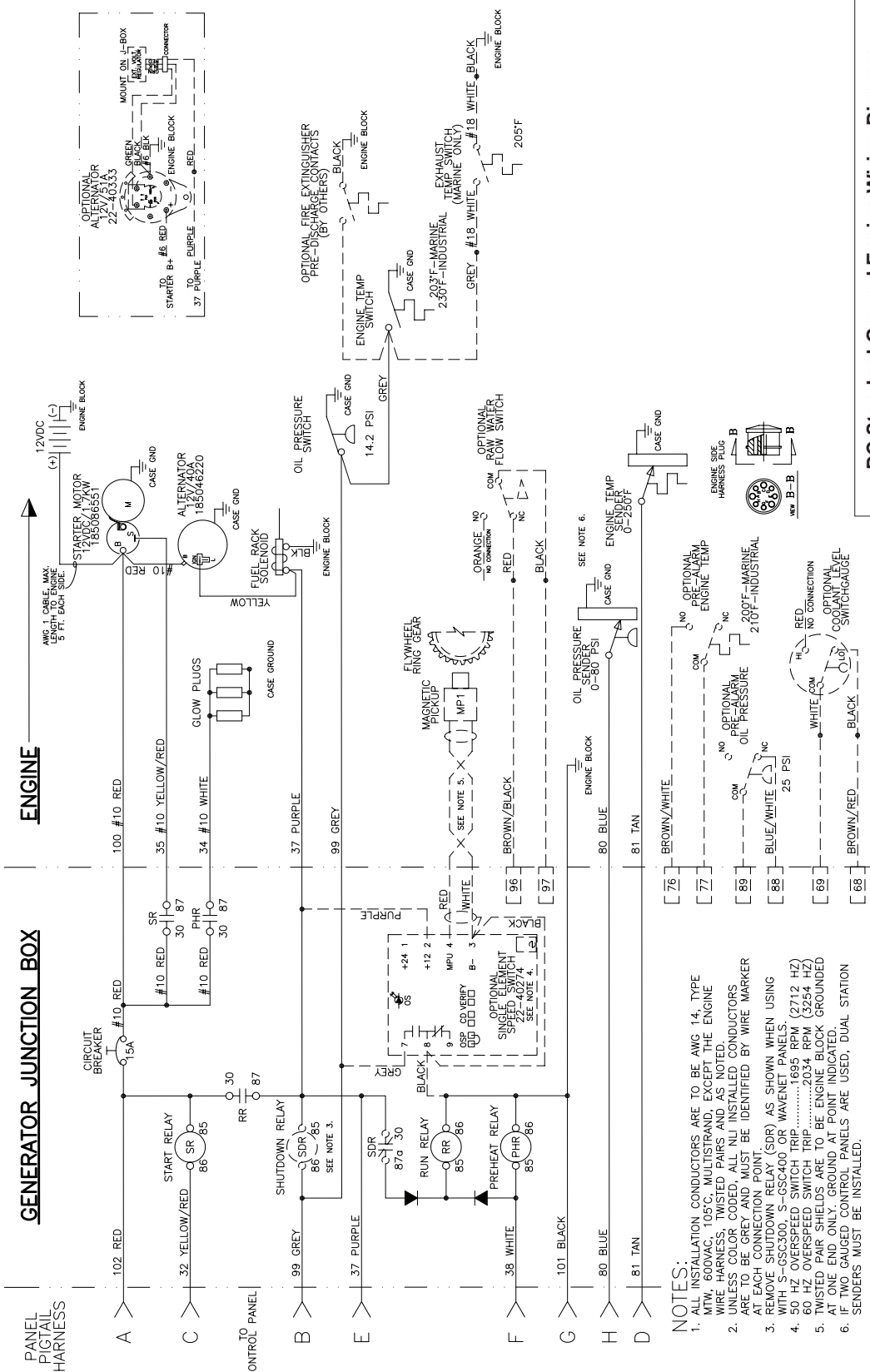

DC Standard Ground Engine Wiring Diagram

Drawing #B-9852

Wiring diagrams are subject to change without notice.

- NOTES:**
1. ALL INSTALLATION CONDUCTORS ARE TO BE AWG 14, TYPE MTW, 600VAC, 105°C, MULTISTRAND, EXCEPT THE ENGINE WIRE HARNESS, TWISTED PAIRS AND AS NOTED.
 2. UNLESS COLOR CODED, ALL NLI INSTALLED CONDUCTORS ARE TO BE GREY AND MUST BE IDENTIFIED BY WIRE MARKER AT EACH CONNECTION POINT.
 3. WIRE HARNESS CONDUCTORS (GDR) AS SHOWN WHEN USING 5-POSITION RELAY (SDR) W/AVENET PANELS.
 4. 50 HZ OVERSPEED SWITCH TRIP1695 RPM (2712 HZ)
 5. 60 HZ OVERSPEED SWITCH TRIP2034 RPM (3254 HZ)
 6. TWISTED PAIR SHIELDS ARE TO BE ENGINE BLOCK GROUNDED AT ONE END ONLY. GROUND AT POINT INDICATED.
 7. IF TWO GAUGED CONTROL PANELS ARE USED, DUAL STATION SENDERS MUST BE INSTALLED.

DC Wiring Diagrams

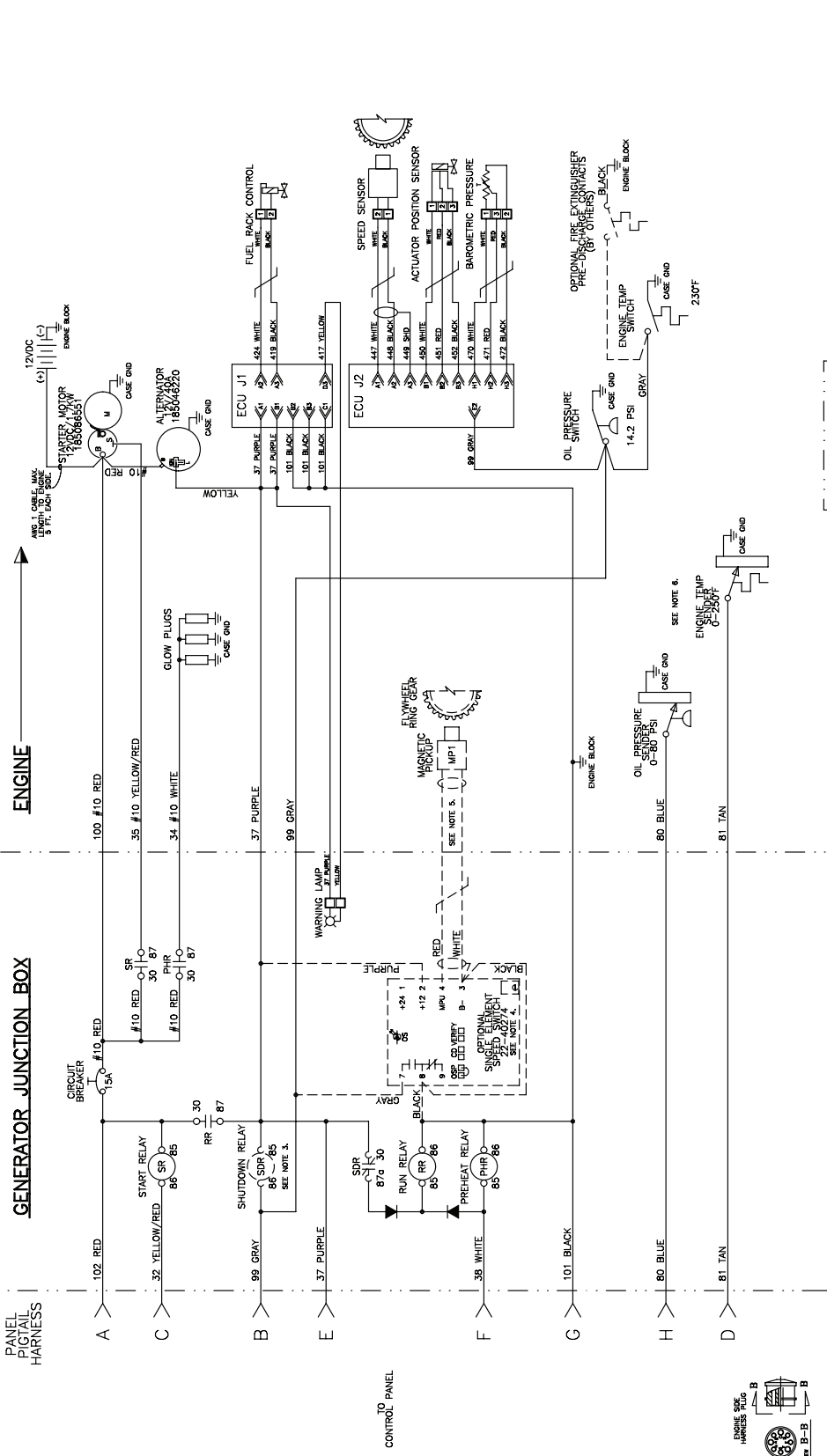

DC Engine Wiring Diagram
NL773LW4E 12VDC standard
Drawing #C-6985B
Wiring diagrams are subject to change without notice.

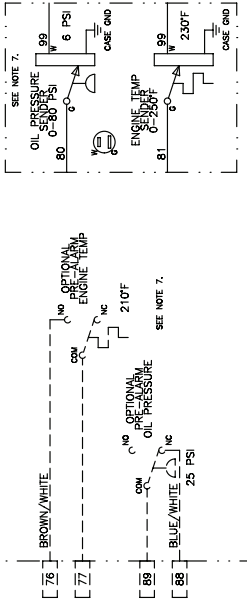

- NOTES:**
1. ILLUMINATION CONDUCTORS ARE TO BE AWG 14, TYPE ATN, INSULATED, UNCOLORED. ALL OTHER WIRE HARNESS TWISTED PAIRS AND AS NOTED.
 2. UNLESS COLOR CODED, ALL NIJ INSTALLED CONDUCTORS ARE TO BE GRAY AND MUST BE IDENTIFIED BY WIRE MARKER.
 3. REMOVE SHUTDOWN RELAY (SDR) AS SHOWN WHEN USING WITH S-GSC300 OR S-GSC400 PANELS.
 4. 60 HZ OVERSPEED SWITCH TRIP2034-RPM (3254-HZ)
 5. TWISTED PAIR SHIELDS IS TO BE ENGINE BLOCK GROUNDED.
 6. IF TWO GAUGED CONTROL PANELS ARE USED, DUAL STATION SENDERS MUST BE INSTALLED.
 7. WHEN PRE-ALARMS ARE INSTALLED REPLACE ORIGINAL SENDERS WITH PRE-ALARM SENDERS (PART #C-6985B).
 8. (GAGE) TERMINAL IS 0.250" WIDE TAB, W (SHUTDOWN) TERMINAL IS 0.187" WIDE TAB.

NON-CURRENT MODEL

Panel Diagrams

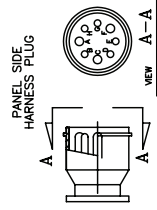
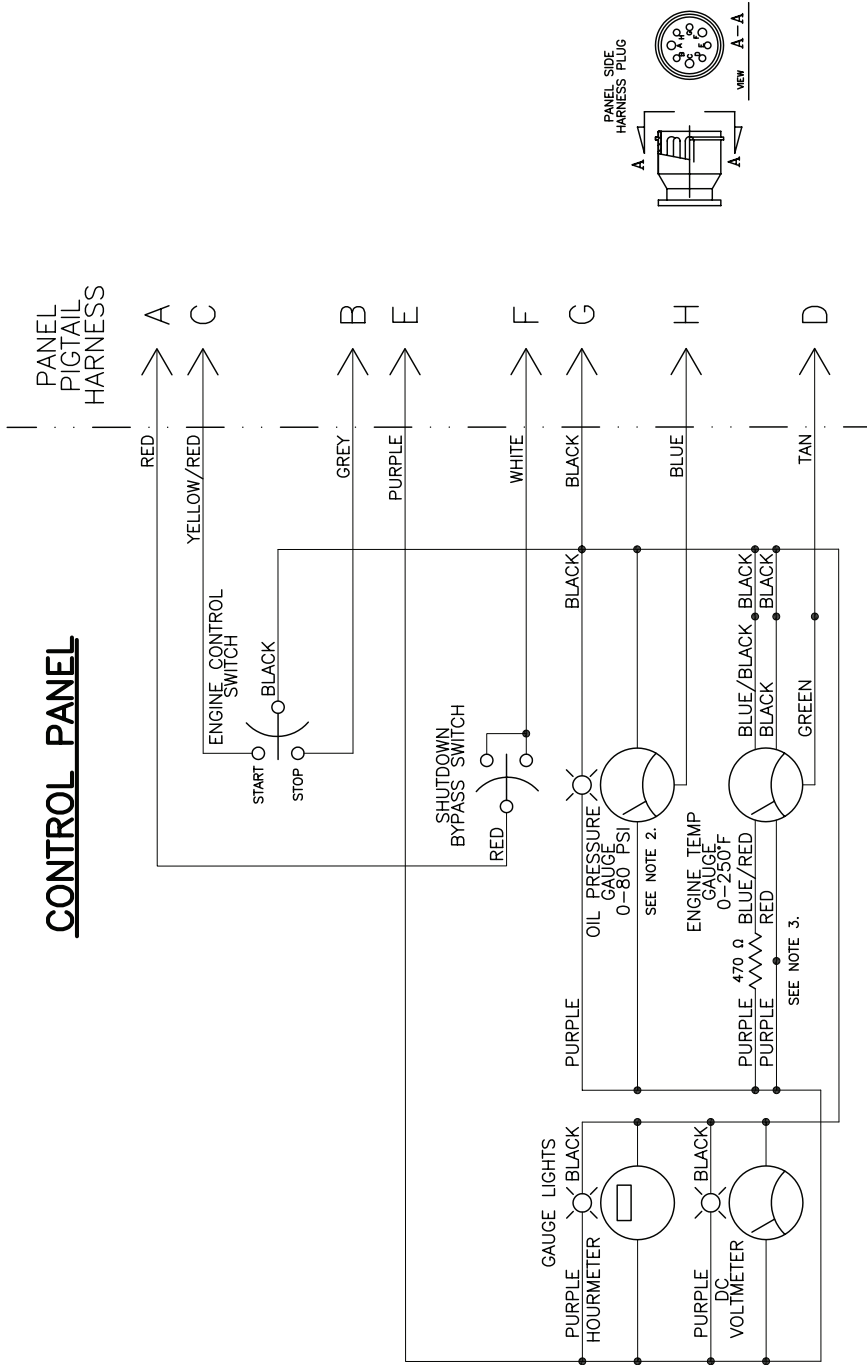

NOTES:

1. ALL INSTALLATION CONDUCTORS ARE TO BE AWG 14, TYPE MTW, 600VAC, 105°C, STRANDED, EXCEPT AS NOTED.
2. OIL PRESSURE GAUGE IS TO BE 0-150 PSI ON PANEL 22-98706.
3. RESISTOR IS TO BE 470 OHMS, 5% 1/4W OR FROM RESISTOR KIT 22-40611.

12 Volt DC Standard Ground Engine Wiring Diagram

NL773LW4 with S-3C

Drawing #A12572B

Wiring diagrams are subject to change without notice.

Panel Diagrams

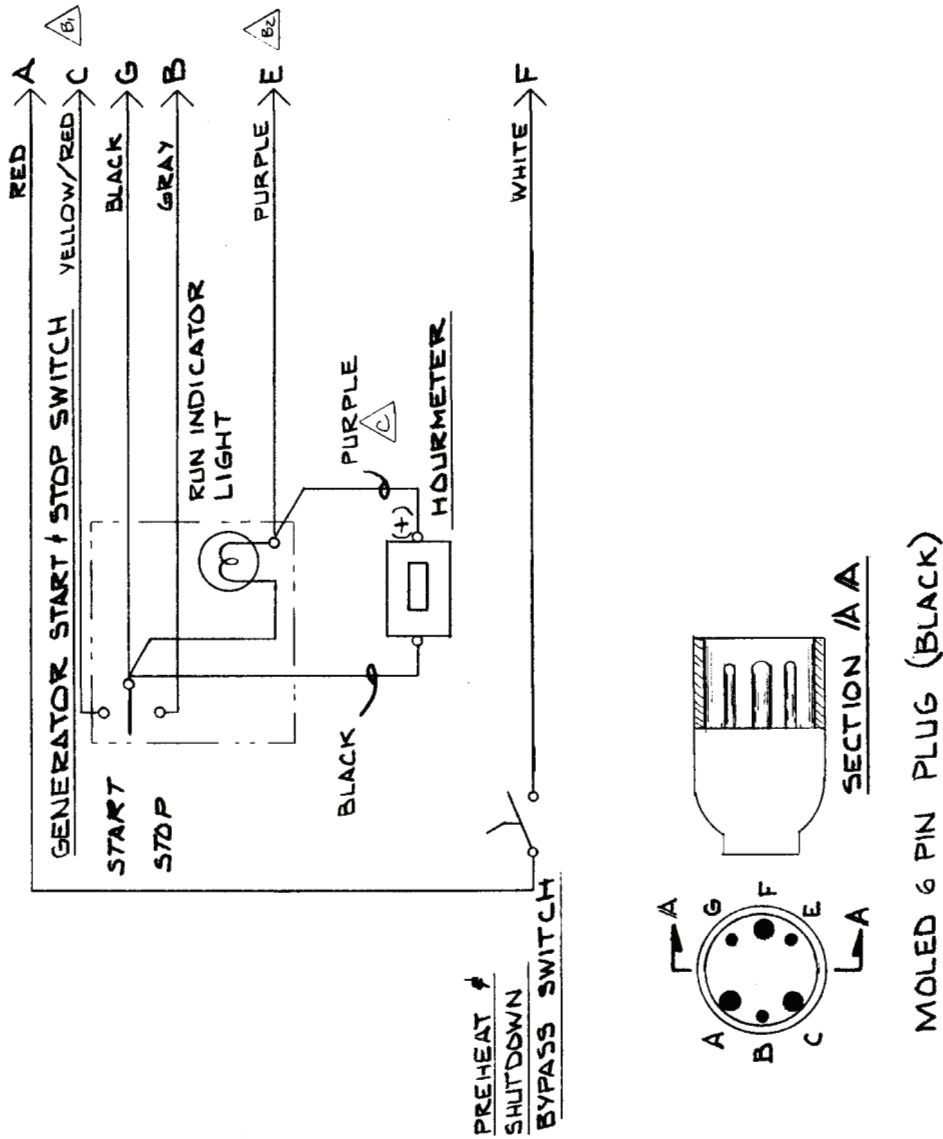

12 Volt DC Standard Ground Engine Wiring Diagram

NL773LW4 with S-1B

Drawing #A-3170

Wiring diagrams are subject to change without notice.

NON-CURRENT MODEL



4420 14th Ave. NW., Seattle WA 98107

Tel: (206) 789-3880 • 1-800-762-0165 • www.northern-lights.com

Northern Lights and Lugger are registered trademarks of Northern Lights, Inc.

© 2020 All rights reserved. Litho USA.